

Dimension

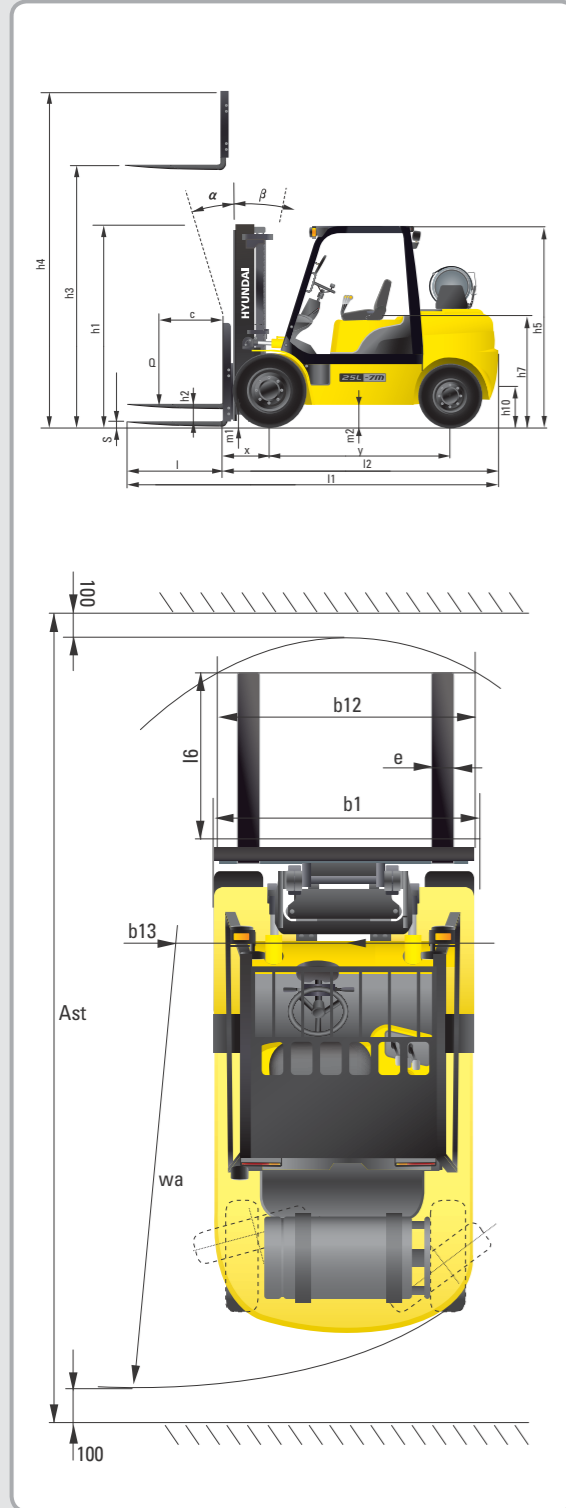

Specification

Identification				
1.1	Manufacturer	Hyundai	Hyundai	Hyundai
1.2	Manufacturer's type designation	25L(G)-7M	30L(G)-7M	33L(G)-7M
1.3	Drive: electric (battery or mains), diesel, petrol, fuel gas, manual	LP / GAS	LP / GAS	LP / GAS
1.4	Type of operation: hand, pedestrian, standing, seated, order-picker	seated	seated	seated
1.5	Load capacity / rated load	Q (kg) 2,500	3,000	3,300
1.6	Load center distance	c (mm) 500	500	500
1.8	Load distance, center of drive axle to fork	x (mm) 468	468	468
1.9	Wheelbase	y (mm) 1,650	1,700	1,700
Weights				
2.1	Service weight	kg 3,860	4,196	4,406
2.2	Axle loading, loaded front/rear	kg 5,608 / 752	6,314 / 882	6,259 / 747
2.3	Axle loading, unloaded front/rear	kg 1,684 / 2,176	1,606 / 2,590	1,551 / 2,855
Wheels, Chassis				
3.1	Tires: solid rubber, superplastic, pneumatic, polyurethane	Pneumatic	Pneumatic	Pneumatic
3.2	Tires size, front	7.00 - 12 - 12PR	8.15 - 15 - 14PR	8.15 - 15 - 14PR
3.3	Tires size, rear	6.50 - 10 - 12PR	6.50 - 10 - 12PR	6.50 - 10 - 12PR
3.5	Wheels, number front x rear (x = driven wheels)	2 x 2	2 x 2	2 x 2
3.6	Track width, front	b10 (mm) 965	1,005	1,005
3.7	Track width, rear	b11 (mm) 980	980	980
Basic Dimensions				
4.1	Mast / fork carriage tilt forward / backward (α / β) degrees	6 / 10	6 / 10	6 / 10
4.2	Lowered mast height	h1 (mm) 2,175	2,190	2,190
4.3	Free lift	h2 (mm) 155	155	155
4.4	Lift height	h3 (mm) 3,300	3,300	3,200
4.5	Extended mast height	h4 (mm) 4,485	4,485	4,385
4.7	Overhead Guard (cab) height	h5 (mm) 2,160	2,180	2,180
4.8	Seat height / standing height	h7 (mm) 1,110	1,130	1,130
4.12	Coupling height	h10 (mm) 283	299	299
4.19	Overall length	l1 (mm) 3,639	3,742	3,782
4.20	Length to face of forks	l2 (mm) 2,607	2,692	2,732
4.21	Overall width	b1 (mm) 1,160	1,230	1,230
4.22	Fork dimensions	s / e / l (mm) 1,050 x 100 x 45	1,050 x 122 x 45	1,050 x 122 x 45
4.23	Fork carriage ISO 2328, class / type A,B	II / A	III / A	III / A
4.24	Fork-carriage width	b12 (mm) 1,102	1,102	1,102
4.31	Ground clearance, loaded, under mast	m1 (mm) 130	145	145
4.32	Ground clearance, centre of wheelbase	m2 (mm) 171	189	189
4.33	Aisle width for pallets 1000 x 1200 crossways	Ast (mm) 3,981	4,066	4,102
4.34	Aisle width for pallets 800 x 1200 lengthways	Ast (mm) 4,181	4,266	4,302
4.35	Turning radius	Wa (mm) 2,313	2,398	2,434
4.36	Smallest pivot point distance	b13 (mm) 714	731	731
Performance Data				
5.1	Travel speed, Unloaded	km/h 17.5	18.5	18.5
5.2	Lift speed, Loaded/Unloaded	mm/s 600 / 610	580 / 610	580 / 610
5.3	Lowering speed, Loaded/Unloaded	mm/s 500 / 450	500 / 450	500 / 450
5.5	Drawbar pull, Loaded	kg 2,569	2,438	2,445
5.7	Gradient performance, Loaded/Unloaded	% 39.3 / 22.0	32.1 / 20.0	29.0 / 18.3
5.10	Service brake	Foot	Foot	Foot
Engine				
6.1	Engine manufacturer / type	GM 3.0L	GM 3.0L	GM 3.0L
6.2	Engine power acc. to ISO 1585 (gasoline)	kW 47.8 (50)	47.8 (50)	47.8 (50)
6.3	Rated speed	1/min 2,400	2,400	2,400
6.4	No. of cylinder / cubic capacity	/cm ³ 4 / 2,967	4 / 2,967	4 / 2,967
Other Details				
8.2	Type of drive control	Power Shift	Power Shift	Power Shift
8.3	Operating pressure	bar 220 / 165	220 / 165	220 / 165
8.4	Oil volume	l 30	30	30
8.5	Noise	db(A) 80	80	80



Some of the photos may include optional equipment.

HYUNDAI LPG/GASOLINE FORKLIFT TRUCKS Applied Tier 4 Engine

25/30/33L(G)-7M

HYUNDAI FORKLIFT
HEAVY INDUSTRIES CO.,LTD.

Head Office (Sales Office)
14th Fl., Hyundai Bldg. 75, Yulgok-ro, Jongno-gu, Seoul 110-796, Korea
TEL (82) (2) 746-4609, 4753 / FAX (82) (2) 746-7444, 7445

Americas Operation : Hyundai Construction Equipment Americas, Inc.
6100 ATLANTIC BOULEVARD NORCROSS GA 30071 U.S.A
TEL (1) 847-678-823-7802 / FAX (1) 847-678-823-7778

Europe Operation : Hyundai Heavy Industries Europe N.V.
VOSSENDAAL 11, 2440 GEEL, BELGIUM
TEL (32) 14-56-2200 / FAX (32) 14-59-3405

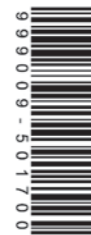

PLEASE CONTACT

www.hyundai-ce.com

2013. 10 Rev.2

HYUNDAI
HEAVY INDUSTRIES CO.,LTD.

We build a better future

NEW criteria of Forklift Trucks

Hyundai introduces a new line of 7M series
LPG / Gasoline forklift trucks.
Excellent power and performance make your
business more profitable.



OPSS (Operator Presence Sensing System)

Control of mast tilting, lifting and lowering is not possible through operation of the appropriate control when the operator is not in the seated position. (Option)

■ Some of the photos may include optional equipment.

The new master on the job-site!

Smooth running, efficient and ergonomically designed, 25L(G)/30L(G)/33L(G)-7M series are made to meet your needs.

47.8kW/2,400rpm (50kW/2,400rpm : Gasoline)

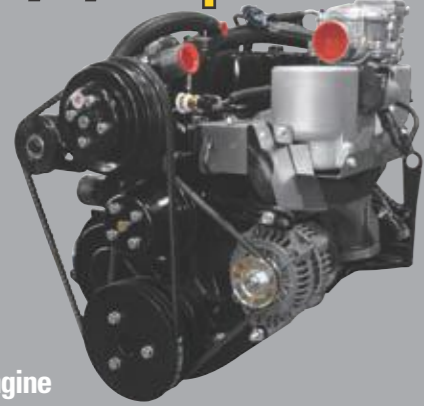

Powerful Engine GM 3.0L Engine

Market approved quality of GM 3.0L engine ensures incomparable performance, durability and additional value to the machine. Powerful and efficient engine provides excellent fuel consumption and excellent torque improved operator's comfort.
(EPA/CARB Tier-IV Certified)

Fast and Stable Performance

Being able to quickly raise and lower the mast, as well as tilt it forward and backward, provides the best operational conditions during unloading.

When the truck is fully loaded, mast lowering speed is carefully controlled to ensure safety by the down control valve.

Mast(Lift and Tilt) Look System. (Option)



Some of the photos may include optional equipment.

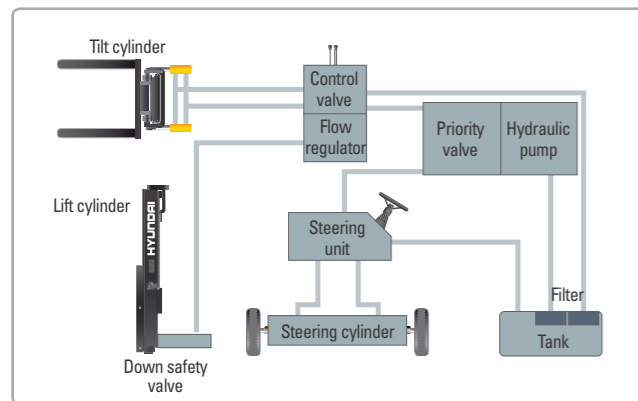

State-of-the-art Hydraulic System

The latest large-capacity hydraulic system reacts quickly during operation, and a low-noise control valve increases both efficiency and durability.



Fully Hydrostatic Power Steering

A hydraulic steering system always guarantees smooth and flexible steering, preventing overrun and kick-back.



Increased Mast Tilting Angle

Utilizing the mast tilting angle of 6 degrees forward and 10 degrees backward, the operator can safely and rapidly perform loading and unloading jobs.

Faster Travel Speed & Better Gradability

The powerful high-output engine provides greater acceleration, better gradability and faster travel speed on any tough terrains or slopes.

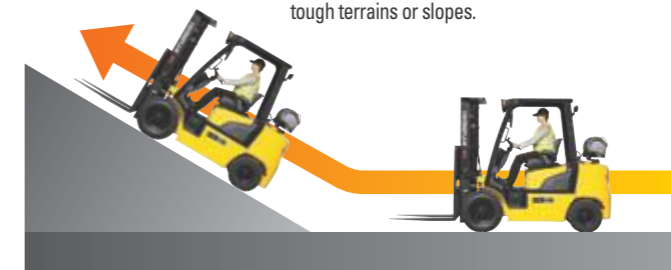

Gradability(Loaded)

25L(G)-7M : 39.3%
30L(G)-7M : 32.1%
33L(G)-7M : 29.0%

Travel Speed(Unloaded)

25L(G)-7M : 17.5 km/h
30L(G)-7M : 18.5 km/h
33L(G)-7M : 18.5 km/h

Ergonomic operator friendly compartment design!

A design based on human engineering relieves fatigue and increases operator's efficiency.

Operator Friendly Gauges and Water-resistant Monitor Panel

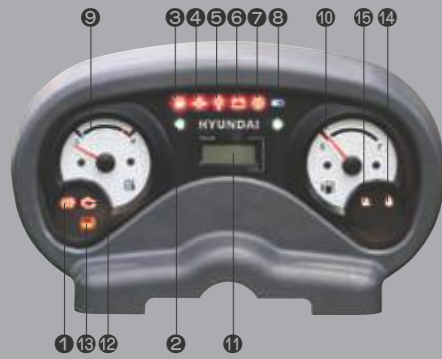

- 1 Parking brake lamp
- 2 Directional indicators
- 3 Fuel warning lamp
- 4 Engine oil warning lamp
- 5 Transmission oil temperature warning lamp
- 6 Battery charging warning lamp
- 7 Air cleaner filter warning light
- 8 Working light indicator
- 9 Water temperature gauge
- 10 Fuel gauge
- 11 Hour meter
- 12 Engine check lamp
- 13 Brake oil warning lamp
- 14 Seat belt warning
- 15 OPS warning



Full Suspension Seat

An attractive and adjustable seat, based on a human engineering design, provides great comfort, safety and durability.



New High Visibility for Safe Operation

The operator is able to work with increased safety and accuracy due to a wider view mast.



Travel Speed Control System (Option)



- ← In-Door : Max. Travel Speed (5~16 km/h)
- ← Out Door : Max Travel Speed (Max vehicle speed)

■ Some of the photos may include optional equipment.



Ergonomically Positioned Pedals

Based on human engineering, the accelerator, brake and inching pedals are optimally positioned for convenience while operating the equipment.



Cup Holder & Console Box

Additional storage spaces are located inside the operating space for operator's convenience.



Quick Response of Operating Control Levers

Only minimal operator's effort is required for precise, safe and productive control.



Adjustable Steering Wheel

Steering wheel with horn button can be adjusted by a lever on the right-hand side for the most comfortable operator position.



Easy and Safe Shift Lever

A single lever on the left side of the steering column gives the operator fast, easy control of direction. The lever must be in the neutral position before the engine can be started.



Secondary Horn

Secondary Horn gives access to lights and horn.

Danger-free through high durability!

Safety and durability are priorities in design of the equipment.



Strong Overhead Guard

The safety overhead guard meets ISO 6055 regulation and protects the operator during hazardous jobs.



Parking Brake

Ratchet type parking brake requires less effort from the operator to set.

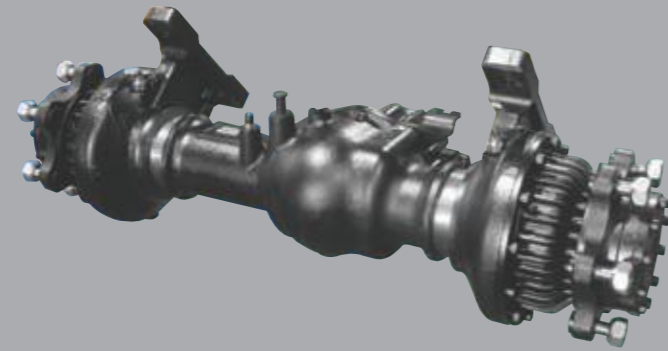

Highly Durable Split Type Drive Axle

The bevel gear set and hub reduction axle smoothly delivers desired torque to the drive wheels.



■ Some of the photos may include optional equipment.



Large Footboard & Hand Grip

Wide "open" step offers convenience and safety when entering and exiting truck.



Expansion Bellows

The expansion bellows absorbs vibration and reduces noise generated from the exhaust gas system and also extends the life cycle of exhaust gas system.



Heavy Duty Single Unit Frame

Heavy duty single unit type frame, designed on the basis of accurate structural analysis, guarantees durability and safety.



Bright, Protected Headlights

Bright, Protected head lights are positioned for exceptional visibility.

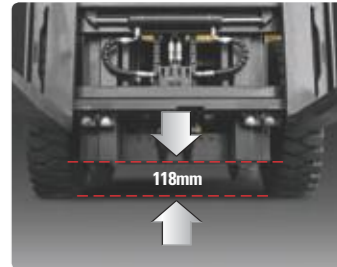

Ground Clearance

The engine and transmission are assembled horizontally and positioned high in the frame to protect major components during operation on rugged surface.

