

## Dimension

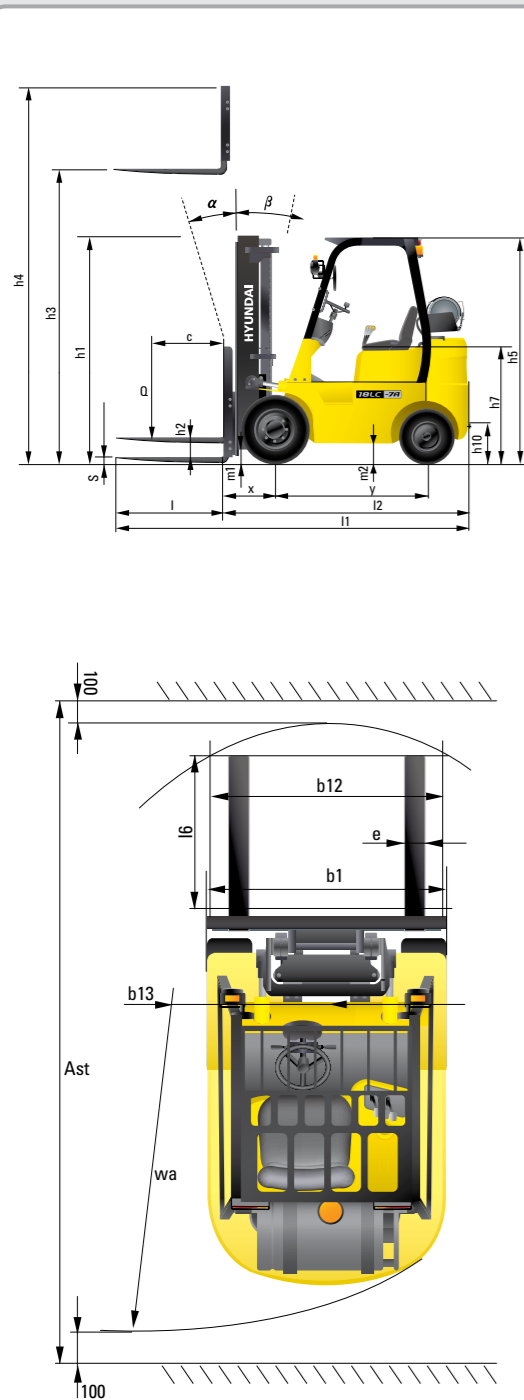

## Specification

Identification				
1.1	Manufacturer	Hyundai	Hyundai	Hyundai
1.2	Manufacturer's type designation	15LC-7M	18LC-7M	20LC-7M
1.3	Drive: electric (battery or mains), diesel, petrol, fuel gas, manual	LP	LP	LP
1.4	Type of operation: hand, pedestrian, standing, seated, order-picker	seated	seated	seated
1.5	Load capacity / rated load	lb 3,000	3,500	4,000
1.6	Load center distance	c (in) 24	24	24
1.8	Load distance, center of drive axle to fork	x (in) 15.5	15.5	15.7
1.9	Wheelbase	y (in) 49.2	49.2	49.2
Weights				
2.1	Service weight	lb 6,234.7	6,673	6,988
2.2	Axle loading, loaded front/rear	lb 8,093.2 / 1,448.4	8,913.3 / 1,618.21	9,773.1 / 1,624.8
2.3	Axle loading, unloaded front/rear	lb 2,425.1 / 3,809.6	2,284 / 4,389.4	2,195.8 / 4,792.8
Wheels, Chassis				
3.1	Tires: solid rubber, superplastic, pneumatic, polyurethane	Solid rubber	Solid rubber	Solid rubber
3.2	Tires size, front (Φ x width)	18 x 6 x 12.125	18 x 6 x 12.125	18 x 7 x 12.125
3.3	Tires size, rear (Φ x width)	14 x 5 x 10	14 x 5 x 10	14 x 5 x 10
3.5	Wheels, number front / rear (x=driven wheels)	x 2 / 2	x 2 / 2	x 2 / 2
3.6	Track width, front	(in) 32.6	32.6	33.9
3.7	Track width, rear	(in) 33.6	33.6	33.6
Basic Dimensions				
4.1	Mast / fork carriage tilt forward / backward (α / β)	degrees 6 / 8	6 / 8	6 / 8
4.2	Lowered mast height	h1 (in) 83.7	83.7	83.7
4.3	Free lift	h2 (in) 4.5	4.5	4.7
4.4	Lift height	h3 (in) 130.9	130.9	131.1
4.5	Extended mast height	h4 (in) 170.6	170.6	170.6
4.7	Overhead load guard (cab) height	h5 (in) 84.4	84.4	84.4
4.8	Seat height / standing height	h7 (in) 40.9	40.9	40.9
4.12	Coupling height	h10 (in) 9	9	9
4.19	Overall length	l1 (in) 117.8	119.2	120.35
4.20	Length to face of forks	l2 (in) 82.4	83.7	84.92
4.21	Overall width	b1 (in) 38.6	38.6	40.63
4.22	Fork dimensions	s / e / l (in) 1.4 x 3.9 x 35.4	1.4 x 3.9 x 35.4	1.4 x 3.9 x 35.4
4.23	Fork carriage ISO 2328, class / type A, B	II / A	II / A	II / A
4.24	Fork-carriage width	b12 (in) 35	35	35
4.31	Ground clearance, loaded, under mast	m1 (in) 3.54	3.54	3.66
4.32	Ground clearance, centre of wheelbase	m2 (in) 3.8	3.74	3.74
4.33	Aisle width for pallets 1000x1200 crossways	Ast (in) 137.3	138.4	139.4
4.34	Aisle width for pallets 800x1200 lengthways	Ast (in) 145.1	146.2	147.2
4.35	Turning radius	Wa (in) 74.5	75.6	76.4
4.36	Smallest pivot point distance	b13 (in) 20.8	20.8	20.8
Performance Data				
5.1	Travel speed, Unloaded	mph 10.5	10.5	10.5
5.2	Lift speed, Loaded / Unloaded	ft / min 128 / 133.9	128 / 133.9	128 / 133.9
5.3	Lowering speed, Loaded / Unloaded	ft / min 98.4 / 88.6	98.4 / 88.6	98.4 / 88.6
5.5	Drawbar pull, Loaded	lb 3,686	3,686	3,699
5.7	Gradient performance, Loaded	% 37.1	32.8	30.6
5.9	Acceleration time, loaded / unloaded (10m)	sec NA	NA	NA
5.10	Service brake	Mechanic / Hydraulic	Mechanic / Hydraulic	Mechanic / Hydraulic
Engine				
6.1	Engine manufacturer / type	MMC 2.0L	MMC 2.0L	MMC 2.0L
6.2	Engine power acc. to ISO 1585	PS 48	48	48
6.3	Rated speed	1 / min 2,300	2,300	2,300
6.4	No. of cylinder / cubic capacity	anz / cm³ 4 / 1,997	4 / 1,997	4 / 1,997
6.5	Fuel consumption acc. To VDI cycle	liter / h NA	NA	NA
Other Details				
8.2	Type of drive control	Power Shift	Power Shift	Power Shift
8.3	Operating pressure (System / Attach)	bar 190 / 150	190 / 150	190 / 150
8.4	Oil volume	ℓ 30	30	30
8.5	Noise	db(A) 80	80	80



■ Some of the photos may include optional equipment.

HYUNDAI LPG FORKLIFT TRUCKS Applied Tier 4 Engine

North America Only

# 15/18/20LC-7M

**HYUNDAI**  
HEAVY INDUSTRIES CO.,LTD.  
FORKLIFT

Head Office (Sales Office)  
14th FL., HYUNDAI BLDG. 140-2, KYE-DONG, JONGNO-GU, SEOUL, KOREA 110-793  
TEL: (82) (2) 746-4505, 4609 FAX: (82) (2) 746-7444-7445

Americas Operation: Hyundai Construction Equipment Americas, Inc.  
6100 ATLANTIC BOULEVARD NORCROSS GA 30071 U.S.A TEL: (1)847-678-823-7802 FAX: (1)847-678-823-7778

Europe Operation: Hyundai Heavy Industries Europe N.V.  
VOSSENDAAL 11, 2440 GEEL, BELGIUM TEL: (32) 14-56-2200 FAX: (32) 14-59-3405

PLEASE CONTACT

www.hyundai-ce.com

2013. 01 Rev.1

**HYUNDAI**  
HEAVY INDUSTRIES CO.,LTD.

We build a better future

# NEW criteria of Forklift Trucks

Hyundai introduces a new line of 7M series LPG forklift trucks. Excellent power and performance make your business more profitable.



### OPSS (Operator Presence Sensing System)

Control of mast tilting, lifting and lowering is not possible through operation of the appropriate control when the operator is not in the seated position.

■ Some of the photos may include optional equipment.

## The new master on the job-site!

Smooth running, efficient and ergonomically designed, 15/18/20LC-7M series are made to meet your needs.

### 48PS/2,300rpm



Powerful Engine  
**MMC 2.0L Engine**

Market approved quality of MMC 2.0L engine ensures incomparable performance, durability and additional value to the machine. Powerful and efficient engine provides excellent fuel economy and excellent torque for improved operation.(EPA/CARB Tier-IV Certified)

### Fast and Stable Performance

Being able to quickly raise and lower the mast, as well as tilt it forward and backward, provides the best operational conditions during unloading.

When the truck is fully loaded, mast lowering speed is carefully controlled to ensure safety by the down control valve.

Mast, Lift and Tilt Lock System is standard.



Some of the photos may include optional equipment.

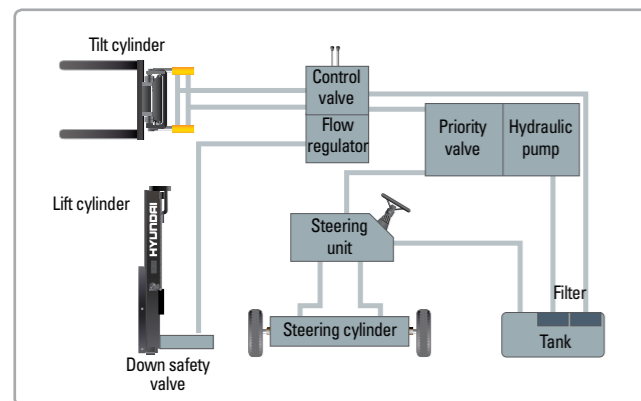

### State-of-the-art Hydraulic System

The latest large-capacity hydraulic system reacts quickly during operation, and a low-noise control valve increases both efficiency and durability.



### Fully Hydrostatic Power Steering

A hydraulic steering system always guarantees smooth and flexible steering, preventing overrun and kick-back.



### Increased Mast Tilting Angle

Utilizing the mast tilting angle of 6 degrees forward and 8 degrees backward, the operator can safely and rapidly perform loading and unloading jobs.

### Faster Travel Speed & Better Gradability

The powerful high-output engine provides greater acceleration, better gradability and faster travel speed on any tough terrains or slopes.



### Gradability(Loaded)

- 15LC-7M : 37.1%
- 18LC-7M : 32.8%
- 20LC-7M : 30.6%

### Travel Speed(Unloaded)

- 15LC-7M : 10.5 mph
- 18LC-7M : 10.5 mph
- 20LC-7M : 10.5 mph

## Ergonomic operator friendly compartment design!

A design based on human engineering relieves fatigue and increases operator's efficiency.

### Operator Friendly Gauges and Water-resistant Monitor Panel



- 1 Parking brake lamp
- 2 Directional indicators
- 3 Fuel warning lamp
- 4 Engine oil warning lamp
- 5 Transmission oil temperature warning lamp
- 6 Battery charging warning lamp
- 7 Air cleaner filter warning light
- 8 Working light indicator
- 9 Water separator lamp
- 10 Pre-heater indicator
- 11 Water temperature gauge
- 12 Fuel gauge
- 13 Hour meter
- 14 Engine check lamp
- 15 Seat belt warning
- 16 OPS warning



### Full Suspension Seat

An attractive and adjustable seat, based on a human engineering design, provides great comfort, safety and durability.



### New High Visibility for Safe Operation

The operator is able to work with increased safety and accuracy due to a wider view mast.



Some of the photos may include optional equipment.

### Travel Speed Control System (Option)



- ← In-Door : Customer Selection
- ← Out Door : Max Vehicle Travel Speed



### Ergonomically Positioned Pedals

Based on human engineering, the accelerator, brake and inching pedals are optimally positioned for convenience while operating the equipment.



### Cup Holder & Console Box

Additional storage spaces are located inside the operating space for operator's convenience.

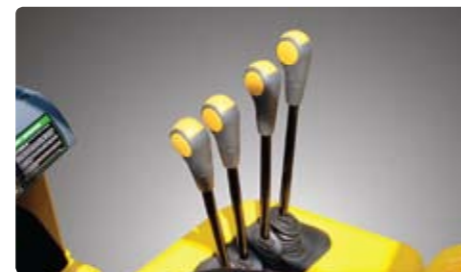

### Quick Response of Operating Control Levers

Only minimal operator's effort is required for precise, safe and productive control.



### Adjustable Steering Wheel

Steering wheel with horn button can be adjusted by a lever on the right-hand side for the most comfortable operator position.



### Easy and Safe Shift Lever

A single lever on the left side of the steering column gives the operator fast, easy control of direction. The lever must be in the neutral position before the engine can be started.



### Secondary Horn

Secondary Horn gives access to lights and horn

## Danger-free through high durability!

Safety and durability are priorities in design of the equipment.



### Strong Overhead Guard

The safety overhead guard meets ISO 6055 regulation and protects the operator during hazardous jobs.



### Parking Brake

Ratchet type parking brake requires less effort from the operator to set.

### Highly Durable Split type Drive Axle

The optimized power transfer parts smoothly deliver desired torque to the drive wheels with wet disc brakes.

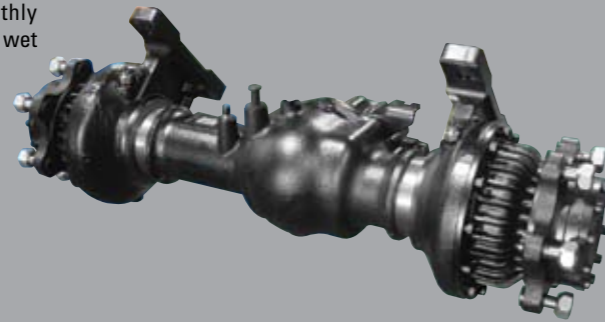

■ Some of the photos may include optional equipment.



### Large Footboard & Hand Grip

Wide "open" step offers convenience and safety when entering and exiting truck.



### Expansion Bellows

The expansion bellows absorbs vibration and reduces noise generated from the exhaust system and also extends the life cycle of exhaust system.



### Electrically Monitored Air Filter

Air cleaner sensor alerts the operator of a restricted air filter and allows replacement before damage.

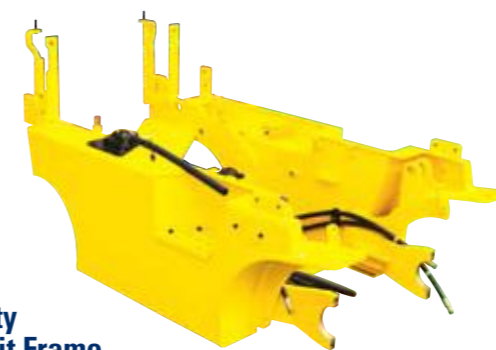

### Heavy Duty Single Unit Frame

Heavy duty single unit type frame, designed on the basis of accurate structural analysis, guarantees durability and safety.



### Bright, Protected Headlights

Bright, Protected head lights are positioned for exceptional visibility.



### Rear Safety Lamp

Rear combination lamps with directional indicators, rear lights and brake lights are positioned for a high level of safety.

# Designed for quick and easy service!

An ideal arrangement of component parts ensures easy access and convenience for maintenance.



### Easy Change Air Cleaner

The air filter is readily accessible for cleaning or replacement. (6inch Cyclone Type)



### Fast Service Access for Daily Fluids Check



### Rotational Battery Installation

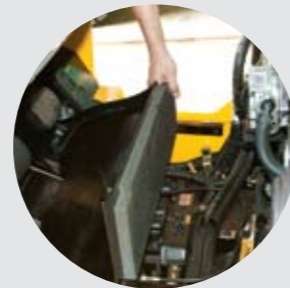

### One Touch, No Tool Floor Plate



### Aluminum Radiator with Superb Protection Against heat



### Improvement in Maintenance of Electric Parts

Various electric parts are centralized in dash board resulting in effortless troubleshooting.



### Easy Maintenance Oil Check

The T/M oil level can be checked easily without any disassembly.



### Brake Fluid Reservoir With Level Switch

When the brake oil level become lower than Min. level, the warning lamp on the clusters comes on.



### An Accessible, Compact Fuse Box for Easy Inspection

## Mast Specification

Mast Type	Maximum Fork Height (in)	Overall Height Lowered (in)	Tilt Angle (deg)		Free Lift (in)						Load Capacity w/o Integral Side Shift 24 in LC (lb)			Load Capacity w/Integral Side Shift 24 in LC (lb)			Truck Weight Unload (lb)			
					With Backrest			With/o Backrest			Single Tire			Single Tire			Single Tire			
			Fwd	Bwd	15LC-7M	18LC-7M	20LC-7M	15LC-7M	18LC-7M	20LC-7M	15LC-7M	18LC-7M	20LC-7M	15LC-7M	18LC-7M	20LC-7M	15LC-7M	18LC-7M	20LC-7M	
2-Stage Limited Free Lift	V250	99.4	67.9	6	8	4.5	4.5	4.7	4.5	4.5	4.7	3,000	3,500	4,000	3,000	3,500	4,000	6,113	6,554	6,869
	V270	107.3	71.9	6	8	4.5	4.5	4.7	4.5	4.5	4.7	3,000	3,500	4,000	3,000	3,500	4,000	6,144	6,585	6,900
	V300	119.1	77.8	6	8	4.5	4.5	4.7	4.5	4.5	4.7	3,000	3,500	4,000	3,000	3,500	4,000	6,188	6,629	6,944
	*V330	130.9	83.7	6	8	4.5	4.5	4.7	4.5	4.5	4.7	3,000	3,500	4,000	3,000	3,500	4,000	6,232	6,673	6,989
	V350	138.8	87.6	6	8	4.5	4.5	4.7	4.5	4.5	4.7	3,000	3,500	4,000	3,000	3,500	4,000	6,263	6,704	7,017
	V370	146.7	91.5	6	8	4.5	4.5	4.7	4.5	4.5	4.7	3,000	3,500	4,000	3,000	3,500	4,000	6,292	6,733	7,048
	V400	158.5	97.4	6	8	4.5	4.5	4.7	4.5	4.5	4.7	3,000	3,500	4,000	3,000	3,500	3,950	6,347	6,788	7,101
	V450	178.1	111.2	6	6	4.5	4.5	4.7	4.5	4.5	4.7	3,000	3,500	4,000	3,000	3,350	3,800	6,493	6,933	7,249
	V500	197.8	121.1	6	6	4.5	4.5	4.7	4.5	4.5	4.7	3,000	2,850	3,000	2,525	2,700	3,125	6,567	7,008	7,321
V550	217.5	130.9	6	5	4.5	4.5	4.7	4.5	4.5	4.7	2,425	2,200	1,870	2,271	2,075	1,750	6,612	7,052	7,368	
3-Stage Full Free Lift	TF370 / TS370	147.0	71.1	6	6	30.2	30.2	30.6	50.0	50.0	50.3	3,000	3,500	4,000	3,000	3,500	4,000	6,464	6,905	7,213
	TF400 / TS400	158.9	75.0	6	6	34.2	34.2	34.5	53.9	53.9	54.2	3,000	3,500	4,000	3,000	3,500	3,900	6,506	6,947	7,262
	TF430 / TS430	170.7	78.9	6	6	38.1	38.1	38.4	57.8	57.8	58.1	3,000	3,500	4,000	3,000	3,500	3,800	6,548	6,989	7,304
	TF450 / TS450	178.5	82.9	6	6	42.0	42.0	42.4	61.8	61.8	62.1	3,000	3,500	3,900	3,000	3,475	3,750	6,590	7,030	7,346
	TF470 / TS470	186.4	84.8	6	6	44.0	44.0	44.3	63.7	63.7	64.1	3,150	3,500	3,925	2,975	3,425	3,700	6,616	7,057	7,372
	TF500 / TS500	198.2	88.8	6	6	48.0	48.0	48.3	67.7	67.7	68.0	3,075	2,850	3,850	2,875	2,700	3,625	6,660	7,101	7,416
	TF550 / TS550	217.9	96.7	6	5	55.8	55.8	56.1	75.6	75.6	75.9	2,775	2,075	2,800	2,800	1,650	2,450	6,742	7,183	7,498
	TF600 / TS600	237.6	104.5	6	5	63.7	63.7	64.0	83.4	83.4	83.7	1,650	1,150	1,425	1,425	1,050	1,325	6,900	7,341	7,657
	TF650 / TS650	257.3	112.4	3	3	71.6	71.6	71.9	91.3	91.3	91.6	1,425	1,100	1,100	1,325	990	1,000	7,000	7,440	7,756
TF700 / TS700	277.0	120.3	3	3	79.4	79.4	79.8	99.2	99.2	99.5	1,100	770	660	990	675	550	7,079	7,520	7,835	

\* TS-Mast : Wide Visible 3 Stage Full Free Lift Mast with 2 Free Lift Cylinders.

\* Standard

## Load Capacity

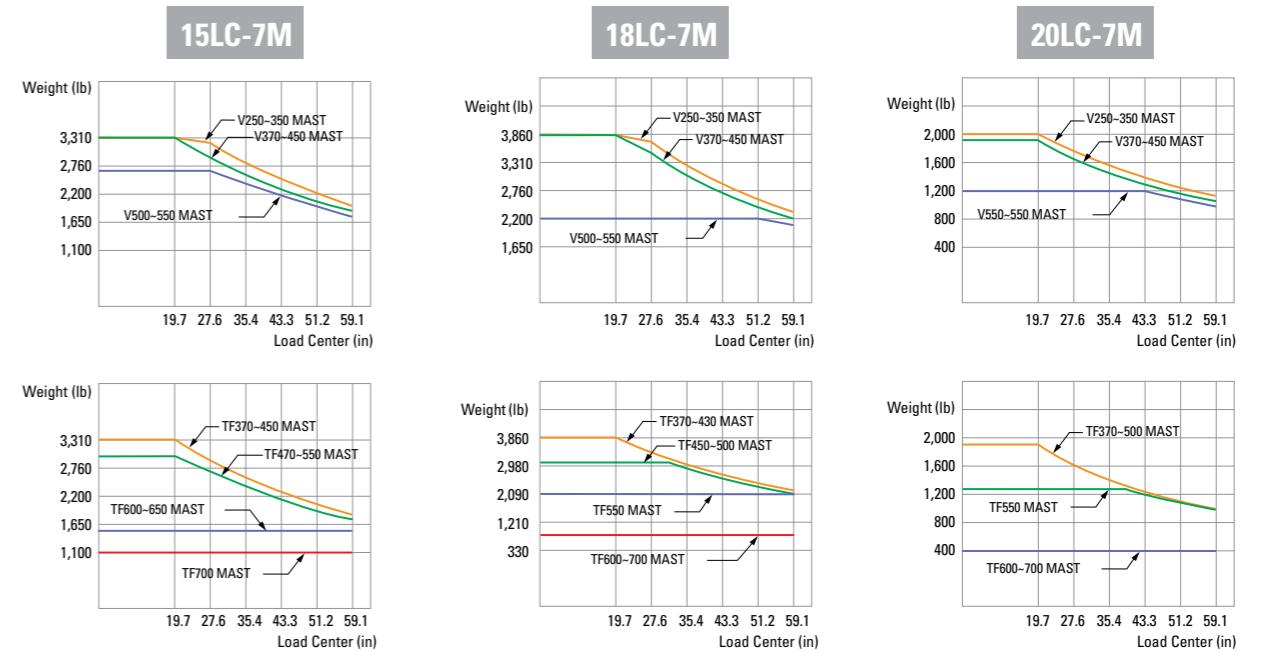

## Optional Items

- **SIDE SHIFT**
- **INTEGRAL SIDE SHIFT**
- **FORK** : 29.5, 33.5, 41.3, 47.2, 53.1, 59.1 in (15/18LC-7M)  
37.4, 39.4, 41.3, 45.3, 44.9, 47.2  
53.1, 59.1, 63.0 in (20LC-7M)
- **OVER SHOE(Extension Fork)** : 51.2, 59.1, 66.9 in
- **TILTING** : 6/6° 6/5°, 3/3°
- **TIRE** : Cushion, Non marking
- **SEAT** : Pocket, Arm Rest, Hip Rest
- **M.C.V** : 4-Spool
- **ATTACH PIPING** : 3 Spool-piping, 4 Spool-piping
- **MASTER SWITCH**
- **BEACON LAMP**
- **HAZARD SWITCH**
- **WORK LAMP**