

ATTACHMENTS COLLECTION





**Quality, craftsmanship and innovation.
The secret lies in precision. Having clear ideas is vital:
we need to know where we want to go and what we want to create.
And at Magni, we throw our all into accomplishing it.**

Riccardo Magni - President

Magni Telescopic Handlers was founded in 2013. Thus began the development of the widest range of telescopic handlers on the market; from rotating telescopic handlers to fixed, heavy-duty models and fixed-boom construction telescopic handlers. Italy was no longer enough and so six further branches have been set up: Magni TH France, Magni UK, Magni America, Magni Deutschland, Magni SA and Magni Asia Pacific. To offer our clients the best technical and commercial service around, we have created a network of over 300 dealers, a number that is constantly increasing. And that is just the beginning of our story.

ATTACH MENTS COLLEC TION



PLATFORMS

Magni offers a wide range of platforms, from the simplest, in order to be able to reach the desired heights in total safety, up to the most special models such as the one dedicated to working in the tunnel or the one for removing asbestos at high altitude. They are the perfect solution for the construction sector and for major maintenance works.

PAG. 07

WINCHES

To effortlessly lift and move objects, more or less bulky, making the most of your Magni's performance, our range of winches is the ideal solution. Compact, sturdy, they are top quality accessories, which bear Magni's constructive signature in every design detail.

PAG. 19

FORK CARRIAGES

Wide range to meet market needs and to assist our operators directly in the workplace. From the simplest fork carriers to those with heavy-duty capacities and larger fork sizes to be able to perform aggravating work in the most extreme conditions.

PAG. 29

JIBS WITH/WITHOUT WINCH

Accessories that are widely used because they are highly versatile and performing, both from a lifting capacity point of view and for the wide choice of capacities offered. As always, Magni has designed a range of accessories specific to market demands, which can be used with every Magni in the catalog.

PAG. 49

BUCKETS

The buckets complete the range of accessories in the Magni world, simplifying the processes in the construction and maintenance sector. They are also excellent allies for the recycling, agriculture and paper supply chain thanks to the various capacities and undisputed performances that they can offer to the professional users.

PAG. 79

HOOKS

Simple but extremely versatile and resistant, Magni approved hooks offer a wide solution for use in the construction world. The range consists of hooks of different capacities to meet the specific needs of the market and to be able to work with all the machine models offered.

PAG. 61

SPECIALS

Category entirely dedicated to accessories with very specific uses. These are codes used to carry out special works, such as removing large trees, cleaning the road with snow shovels, installing glass at high altitude and servicing aircraft. In Magni we are known for the tailoring skills to sew ad hoc solutions to each specific market request, even for the most demanding customers.

PAG. 85

CLAMPS

Very specific accessories designed on stringent needs felt above all in the mining and extractive sector, and lately also of recycling. This is a range of accessories designed for changing tires of large truck dumpers used in the mine, capable of adapting to the performance of each Magni sold in the market.

PAG. 69

VERSATILITY GUARANTEED WITH THE MAGNI RANGE OF ATTACHMENTS



The great potential of Magni machines is fully realized by choosing the right accessory among all possible options in the range. All accessories are interchangeable giving the possibility to have a machine capable of performing more than one task simply by changing accessories. If your Magni model is dated, we ask you to contact the sales force closest to you, to check its compatibility. All our attachments are available for almost all the markets and countries, please get in contact with your nearest dealers or Magni branch to have the best solution tailored for your needs.

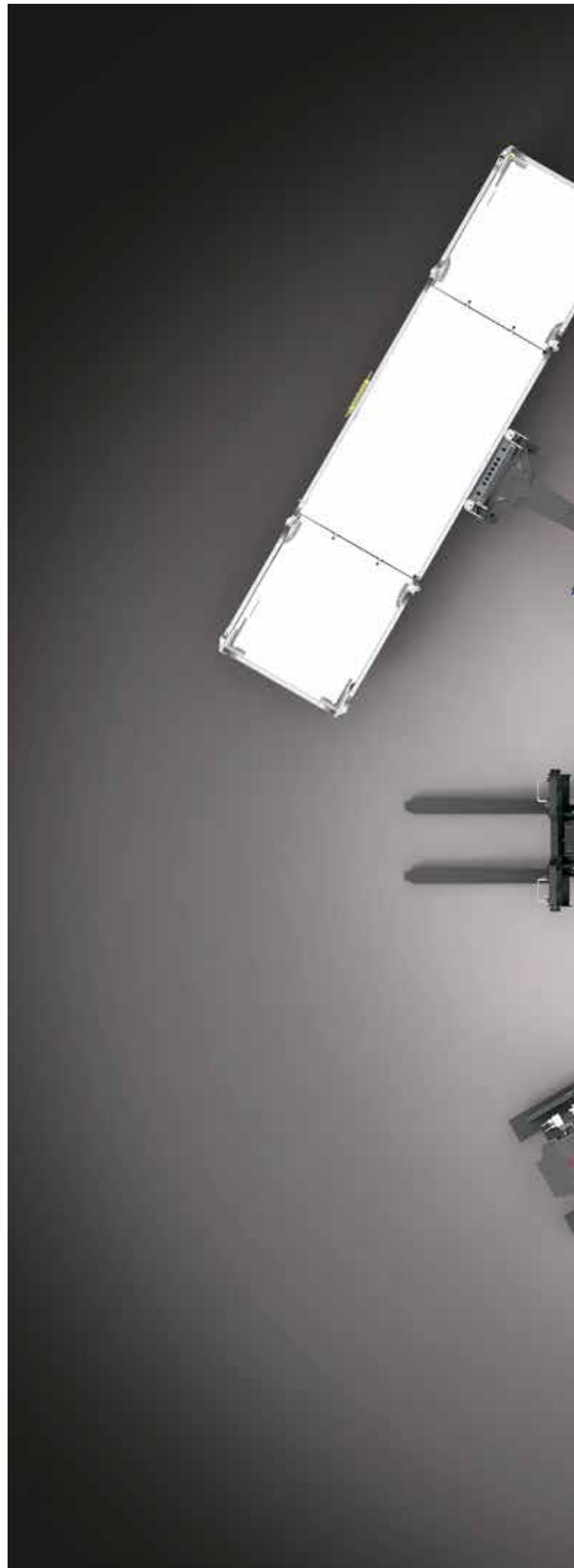

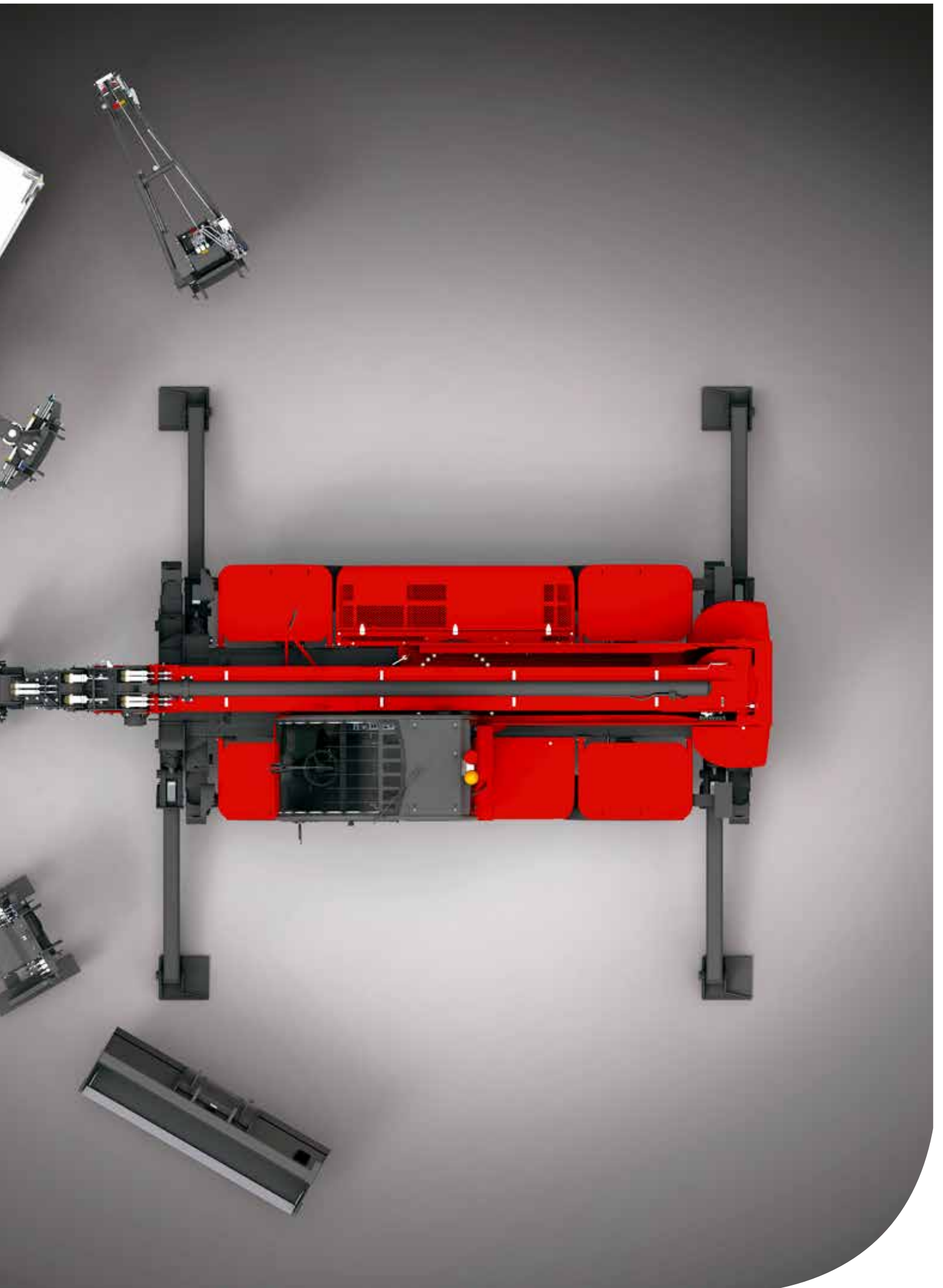

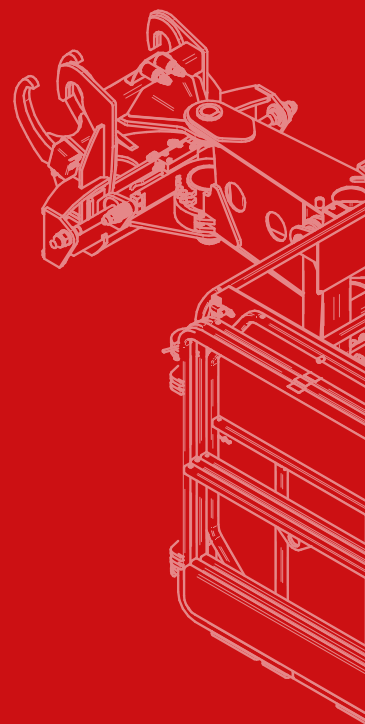

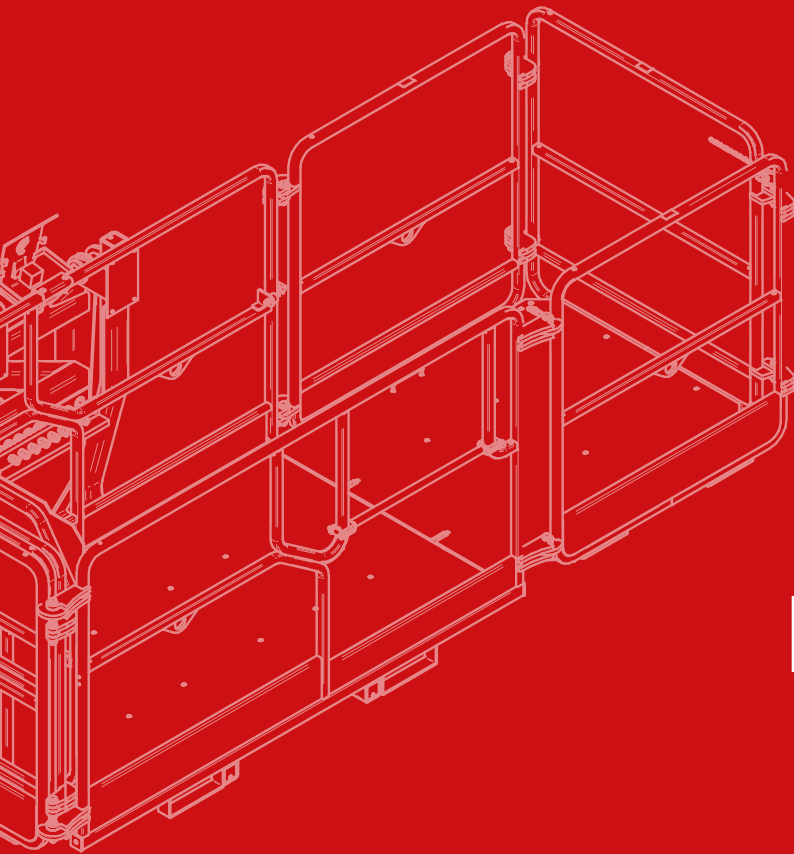

PLATFORMS

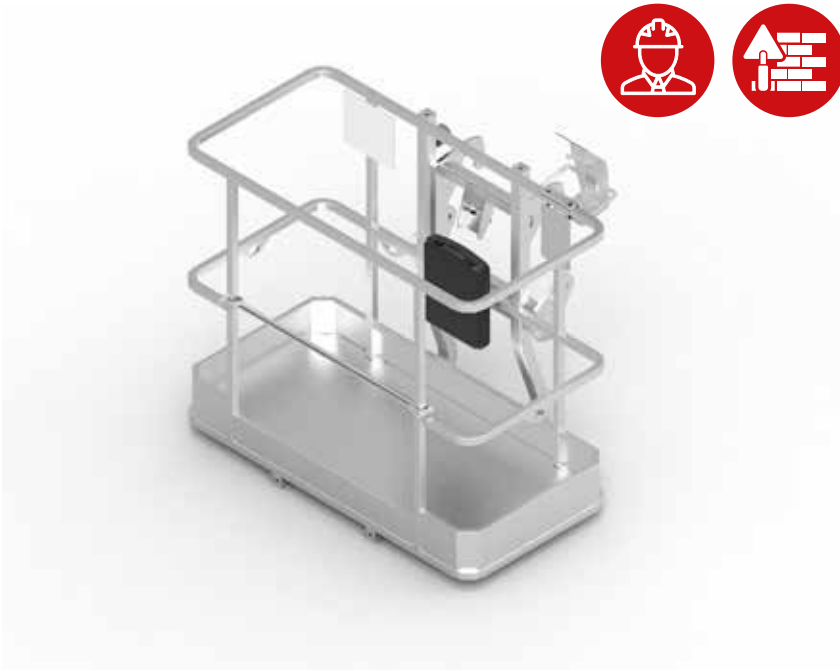

PLATFORM

ATT - 01 - 001 Q-FIT I

Non-extendable platform with 250 kg maximum capacity, type approved to carry two persons. Galvanised, reinforced steel structure. Non-slip floor covering to ensure the utmost safety when working at height.

REMOTE CONTROL REQUIRED

Suitable for
RTH - HTH - TH

P1,4				
250 kg	1,400 x 700 mm	X	2	



ROTATING PLATFORM

ATT - 01 - 003 Q-FIT I

Rotating platform (+/- 90°) with 250 kg maximum capacity, type approved to carry two persons. Galvanised, reinforced steel structure. Non-slip floor covering to ensure the utmost safety when working at height.

REMOTE CONTROL REQUIRED

Suitable for
RTH - TH

RP1,4				
250 kg	1,400 x 700 mm	+ / - 90°	2	



ROTATING PLATFORM

ATT - 01 - 005 Q-FIT I

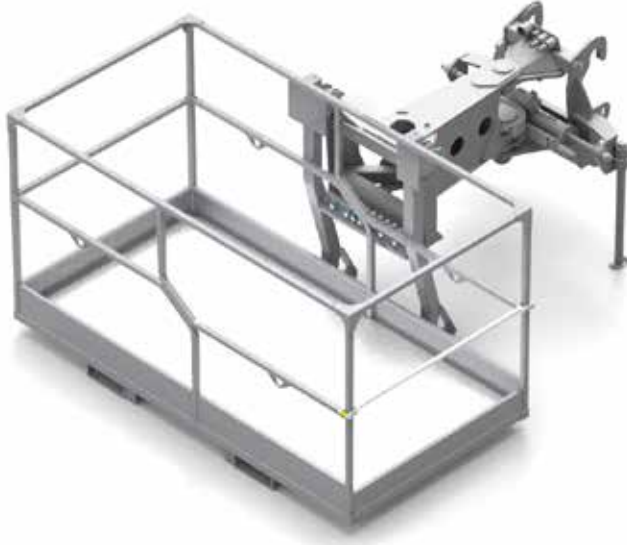

Non-extendable rotating platform with 500 kg maximum capacity, type approved to carry three persons. Galvanised, reinforced steel structure. Non-slip floor covering to ensure the utmost safety when working at height. Platform equipped with overload sensor and rack with a practical anti-shock system which ensures smooth, even rotational movements when stopping and starting movement. Equipped with practical fork slots for movement during storage.

REMOTE CONTROL REQUIRED

Suitable for
RTH - TH

RP2,2

500 kg	2,200 x 1,100 mm	+ / - 90°	3	✓



EXTENDABLE ROTATING PLATFORM 4.5

ATT - 01 - 007 Q-FIT I



Extendable rotating platform with 500 kg maximum capacity, type approved to carry three persons. Galvanised, reinforced steel structure. Non-slip floor covering to ensure the utmost safety when working at height. Platform equipped with overload sensor and rack with a practical anti-shock system which ensures smooth, even rotational movements when stopping and starting movement. Equipped with a practical, efficient extension system allowing you to gain one metre per side. Equipped with practical fork slots for movement during storage.

REMOTE CONTROL REQUIRED

Suitable for
RTH - TH

REP 2-4,5

500 kg	2,350 - 4,530 x 1,100 mm	+ / - 90°	3	✓



EXTENDABLE ROTATING PLATFORM 5.5

ATT - 01 - 009 Q-FIT I

Extendable rotating platform with 500 kg maximum capacity, type approved to carry three persons. Galvanised, reinforced steel structure. Non-slip floor covering to ensure the utmost safety when working at height. Platform equipped with overload sensor and rack with a practical anti-shock system which ensures smooth, even rotational movements when stopping and starting movement. Equipped with a practical, efficient extension system allowing you to gain one and a half metres per side. Equipped with practical fork slots for movement during storage.

REMOTE CONTROL REQUIRED

Suitable for
RTH - TH



REP 2-5.5

500 kg	2,050 - 5,480 mm	+ / - 90°	3	



EXTENDABLE ROTATING PLATFORM 6.5

ATT - 01 - 011 Q-FIT I

Extendable rotating platform with 500 kg maximum capacity, type approved to carry three persons. Galvanised, reinforced steel structure. Non-slip floor covering to ensure the utmost safety when working at height. Platform equipped with overload sensor and rack with a practical anti-shock system which ensures smooth, even rotational movements when stopping and starting movement. Equipped with a practical, efficient extension system allowing you to gain two metres per side. Equipped with practical fork slots for movement during storage.

REMOTE CONTROL REQUIRED

Suitable for
RTH - TH



REP 2-6.5

500 kg	2,420 - 6,530 mm	+ / - 90°	3	

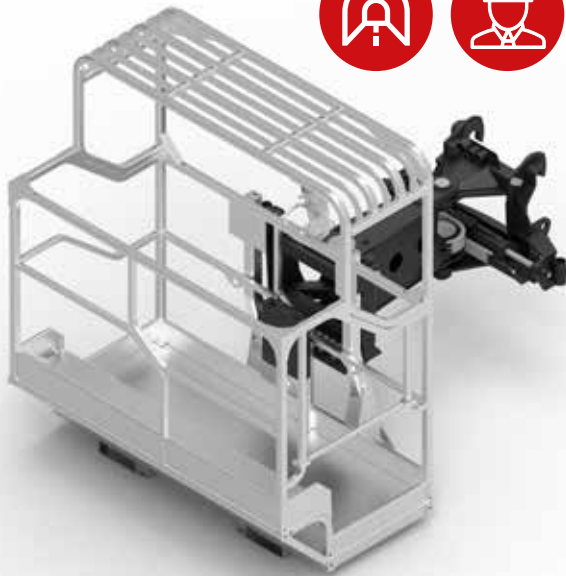

ROTATING PLATFORM FOR TUNNELS







ATT - 01 - 013 Q-FIT I

Special platform for use in tunnels, with a maximum capacity of 500 kg and type approved for three persons. Galvanised, reinforced steel structure. Non-slip floor covering to ensure the utmost safety when working at height. Equipped with integrated protection grille on the upper part of the basket to protect against falling debris. Equipped with rack with a practical anti-shock system which ensures smooth, even rotational movements when stopping and starting movement. Equipped with practical fork slots for movement during storage.

 REMOTE CONTROL REQUIRED

Suitable for
RTH - TH

CRP 5

				
500 kg	1,810 - 1,000 mm	+/- 90°hydraulic	3	









EXTENDABLE ROTATING PLATFORM + WINCH 600KG

ATT - 01 - 026 Q-FIT I

Extendable rotating platform with 500 kg maximum capacity, type approved to carry three persons. Galvanised, reinforced steel structure. Non-slip floor covering to ensure the utmost safety when working at height. Platform equipped with overload sensor and rack with a practical anti-shock system which ensures smooth, even rotational movements when stopping and starting movement. Equipped with a practical, efficient extension system allowing you to gain one metre per side. Equipped with practical fork slots for movement during storage. Equipped with a practical winch, 600 kg capacity. This can rotate +/- 90° manually, and lift 0-64°.

REMOTE CONTROL REQUIRED

Suitable for
RTH - TH

REP 5.2-4,5 W0,6

500 kg	2.350 - 4,500 mm	+ / - 90°	3	600 kg	2,015 mm	+ / - 90° manual	0° /64°	49 m	

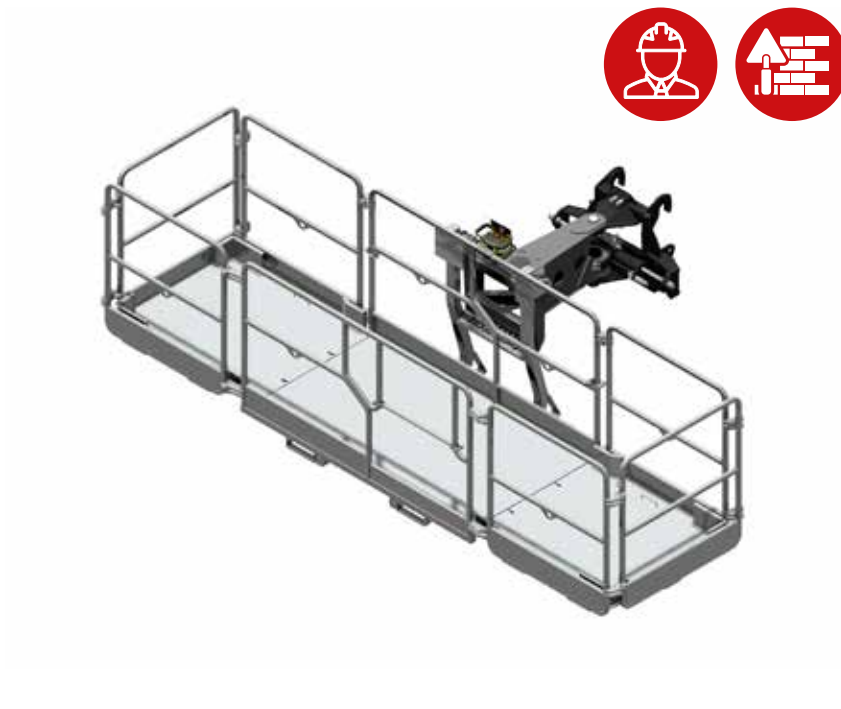

EXTENDABLE ROTATING PLATFORM 1000 KG

ATT - 01 - 016 Q-FIT I

Extendable rotating platform with 1,000 kg maximum capacity, type approved to carry three persons. Galvanised, reinforced steel structure. Non-slip floor covering to ensure the utmost safety when working at height. Platform equipped with overload sensor and rack with a practical anti-shock system which ensures smooth, even rotational movements when stopping and starting movement. Equipped with a practical, efficient extension system allowing you to gain two metres per side. Equipped with practical fork slots for movement during storage.

REMOTE CONTROL REQUIRED

Suitable for
RTH - TH

REP 10.2-4,7

1,000 kg	2,350 - 4,700 mm	+ / - 90°	3	

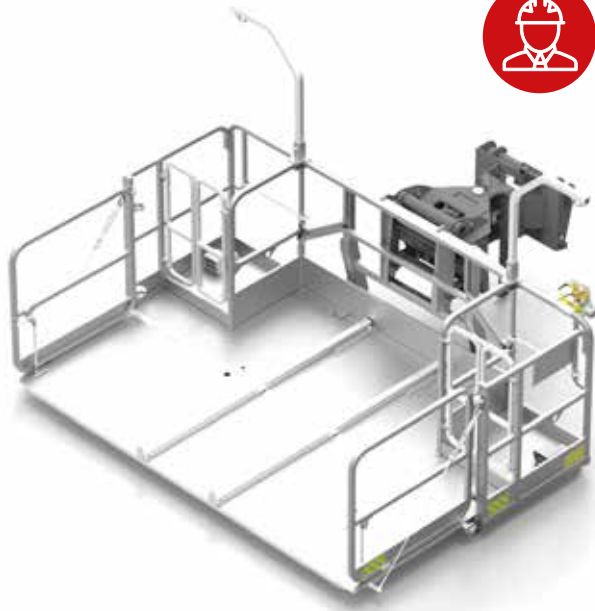

EXTENDABLE ROTATING PLATFORM ASBESTOS 1000KG + FRONTAL OPENING

ATT - 01 - 018 Q-FIT I

Special platform dedicated to the removal of asbestos at height, with a capacity of up to 1,000 kg. Type approved for two persons. This is composed of two working stations equipped with deadman pedal on both and two anchor points, one low and one high, to allow egress at height. Non-slip floor covering to ensure the utmost safety when working at height. The front part tilts, allowing for easy offloading of materials. Platform equipped with overload sensor and rack with a practical anti-shock system which ensures smooth, even rotational movements when stopping and starting movement. Equipped with practical fork slots for movement during storage.

REMOTE CONTROL REQUIRED

Suitable for
RTH - TH

RPRAB 10-3,5

1,000 kg	Open: 3.350 x 2,190 mm Close: 3.350 x 1,050 mm	+/- 90°hydraulic	2	✓

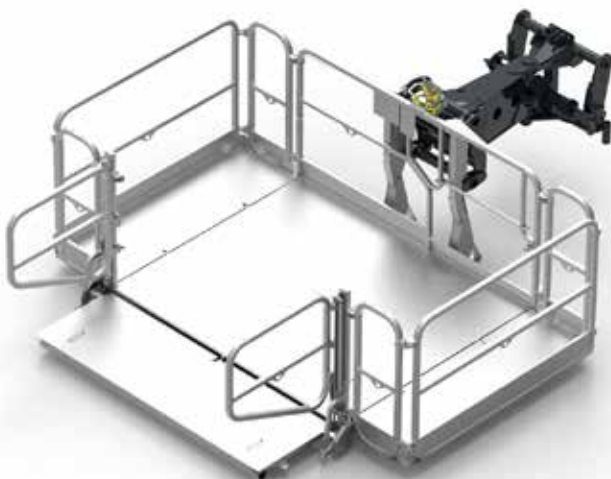

EXTENDABLE ROTATING PLATFORM FOR ROOFS

ATT - 01 - 020 Q-FIT I

Extendable rotating platform with 1,000 kg maximum capacity, type approved to carry three persons and suitable for egress at height. This is composed of an openable guide which facilitates operator ingress/ egress. The platform has sensors which disable movements with the basket open. Galvanised, reinforced steel structure. Non-slip floor covering to ensure the utmost safety when working at height. Platform equipped with overload sensor and rack with a practical anti-shock system which ensures smooth, even rotational movements when stopping and starting movement.

REMOTE CONTROL REQUIRED

Suitable for
RTH - TH

RRP 10.2,5-3,5

1,000 kg	Open: 3,500 x 1,800 mm Closed: 2,500 x 1,800 mm	+/- 90° hydraulic	3	2,020 mm	740 mm	✓



FIXED TELESCOPIC PLATFORM

ATT - 01 - 022 Q-FIT I

Extendable telescopic platform with 200 kg maximum capacity, type approved to carry two persons. Galvanised, reinforced steel structure. Non-slip floor covering to ensure the utmost safety when working at height. Rotation +/- 90° is made with a hydraulic actuator.

REMOTE CONTROL REQUIRED

Suitable for
RTH - HTH - TH

TP 2,10

200 kg	1,400 x 700 mm	+ / - 90°	2	6,430 - 10,200 mm	6,440 - 9,770 mm	3,330 mm	✓



TELESCOPIC PLATFORM THAT CAN WORK EITHER POSITIVE OR NEGATIVE TP O/U

ATT - 01 - 024 Q-FIT I

Extendable rotating telescopic platform with a maximum capacity of 200 kg. It is type approved to carry two persons. Galvanised, reinforced steel structure. Non-slip floor covering to ensure the utmost safety when working at height. Equipped with boom position sensor, which can be easily consulted on the display in the cab. Rotation 340° is made with a hydraulic actuator.

REMOTE CONTROL REQUIRED

Suitable for
RTH - HTH - TH

TP O-U

200 kg	1,240 x 800 mm	340° hydraulic	2	5,100 - 6,900 mm	4,975 - 6,705 mm	6,350 - 8,080 mm	1,800 mm	✓



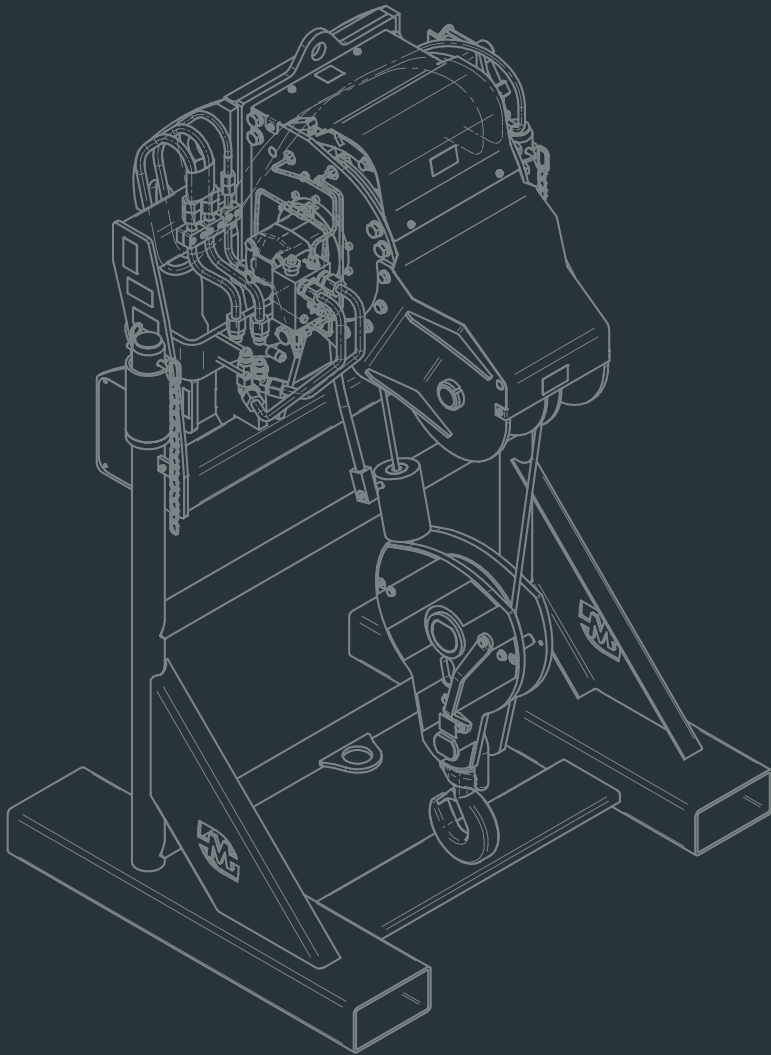

WINCHES







WINCH 2,700KG

ATT - 02 - 001 Q-FIT I

Winch with swivelling type-approved hook with 2,700 kg capacity. Attachment equipped with rope pressure roller and hydraulic limit switch system for rope raising/lowering. Metal storage support included in code.

Suitable for
RTH - TH

W2,7				
				
2,700 kg	10 mm	25 m	24 m/min	✓







WINCH 3,500KG

ATT - 02 - 002 Q-FIT I

Winch with swivelling type-approved hook with 3,500 kg capacity. Attachment equipped with rope pressure roller and hydraulic limit switch system for rope raising/lowering. Metal storage support included in code.

Suitable for
RTH - TH

W3,5				
				
3,500 kg	10 mm	25 m	24 m/min	✓



WINCH 6,000KG

ATT - 02 - 004 Q-FIT I

Winch with swivelling type-approved hook with 6,000 kg capacity. Attachment equipped with rope pressure roller and hydraulic limit switch system for rope raising/lowering. Metal storage support included in code.



Suitable for
RTH - TH

W6

6,000 kg	12 mm	27 m	19 m/min	



WINCH 8,000KG

ATT - 02 - 006 Q-FIT I

Winch with swivelling type-approved hook with 8,000 kg capacity. Attachment equipped with rope pressure roller and hydraulic limit switch system for rope raising/lowering. Metal storage support included in code.



Suitable for
RTH - HTH

W8

8,000 kg	16 mm	40 m	13 m/min	







WINCH 16,000KG

ATT - 02 - 008 Q-FIT I

Winch with swivelling type-approved hook with 16,000 kg capacity. Attachment equipped with rope pressure roller and hydraulic limit switch system for rope raising/lowering. Metal storage support included in code.

**Suitable for
HTH**

W16

				
16,000 kg	16 mm	20 m	10 m/min	✓

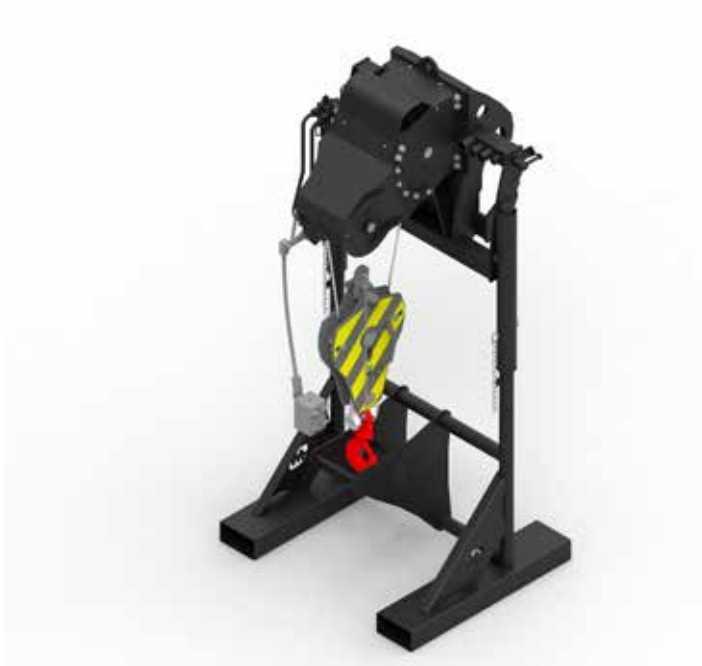





WINCH 3,500KG/1,750KG

ATT - 02 - 009 Q-FIT I

Winch with swivelling type-approved hook, which can be configured to two capacities: 3,500 kg dual and 1,750 kg single. Attachment equipped with rope pressure roller and hydraulic limit switch system for rope raising/lowering. Metal storage support included in code.

**Suitable for
RTH - TH**

W 3,5 - 1,75

				
1,750 / 3,500 kg	10 mm	50/25 m	48/24 m/min	✓



WINCH 3,000KG/6,000KG

ATT - 02 - 010 Q-FIT I

Winch with swivelling type-approved hook, which can be configured to two capacities: 6,000 kg dual and 3,000 kg single. Attachment equipped with rope pressure roller and hydraulic limit switch system for rope raising/lowering. Metal storage support included in code.



Suitable for
RTH - TH

W 3 - 6

3,000 / 6,000 kg	12 mm	58/26 m	32/16 m/min	✓



WINCH 13,000KG

ATT - 02 - 018 Q-FIT I

Winch with swivelling type-approved hook with 13,000 kg capacity. Attachment equipped with rope pressure roller and hydraulic limit switch system for rope raising/lowering. Metal storage support included in code.



Suitable for
RTH - HTH

W13

13,000 kg	16 mm	26 m	8 m/min	✓

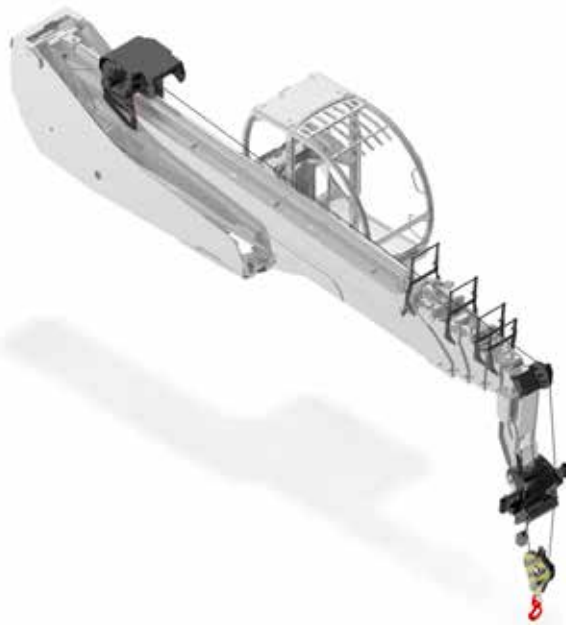

WINCH FITTED AT THE BASE OF THE BOOM 6T

ATT - 02 - 012 Q-FIT I

Winch with swivelling type-approved hook, which can be configured to two capacities: 6000 kg dual and 3000 kg single. Attachment equipped with rope pressure roller and hydraulic limit switch system for rope raising/lowering. Metal storage support included in code. Improved performance compared to the W6 thanks to the configuration of the attachment itself, which has the drum on the boom and not directly fastened to the winch.

Suitable for RTH 6.26

WB6

3,000/6,000 kg	12 mm	85 m (single pull 3 ton) / 42.5 m (double pull 6 ton)	32 m/min (single pull) / 17 m/min (double pull)	✓

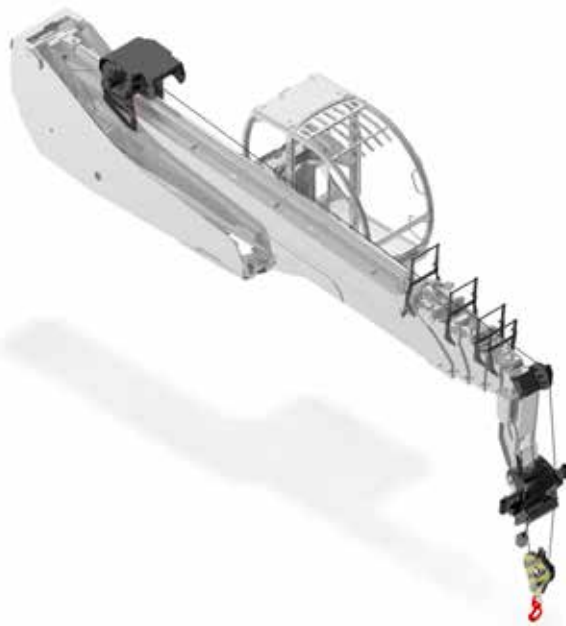

WINCH FITTED AT THE BASE OF THE BOOM 6T

ATT - 02 - 013 Q-FIT I

Winch with swivelling type-approved hook, which can be configured to two capacities: 6,000 kg dual and 3,000 kg single. Attachment equipped with rope pressure roller and hydraulic limit switch system for rope raising/lowering. Metal storage support included in code. Improved performance compared to the W6 thanks to the configuration of the attachment itself, which has the drum on the boom and not directly fastened to the winch.

Suitable for RTH 6.30

WB6

3,000/6,000 kg	12 mm	85 m (single pull 3 ton) / 42.5 m (double pull 6 ton)	32 m/min (single pull) / 17 m/min (double pull)	✓



WINCH FITTED AT THE BASE OF THE BOOM 6T ARTICULATED FOR ROAD CIRCULATION

ATT - 02 - 014 Q-FIT I

Winch with joint which allows it to be tilted back to allow use on roads. Winch with swivelling type-approved hook, which can be configured to two capacities: 6,000 kg dual and 3,000 kg single. Attachment equipped with rope pressure roller and hydraulic limit switch system for rope raising/lowering. Metal storage support included in code. Improved performance compared to the W6 thanks to the configuration of the attachment itself, which has the drum on the boom and not directly fastened to the winch.

Suitable for RTH 6.30

AWB6

3,000/6,000 kg	12 mm	85 m (single pull 3 ton) / 42.5 m (double pull 6 ton)	32 m/min (single pull) / 17 m/min (double pull)	✓



WINCH FITTED AT THE BASE OF THE BOOM 6T

ATT - 02 - 016 Q-FIT I

Winch with swivelling type-approved hook, which can be configured to two capacities: 6,000 kg dual and 3,000 kg single. Attachment equipped with rope pressure roller and hydraulic limit switch system for rope raising/lowering. Metal storage support included in code. Improved performance compared to the W6 thanks to the configuration of the attachment itself, which has the drum on the boom and not directly fastened to the winch.

Suitable for RTH 6.35/6.39

WB6

3,000/6,000 kg	12 mm	85 m (single pull 3 ton) / 42.5 m (double pull 6 ton)	32 m/min (single pull) / 17 m/min (double pull)	✓

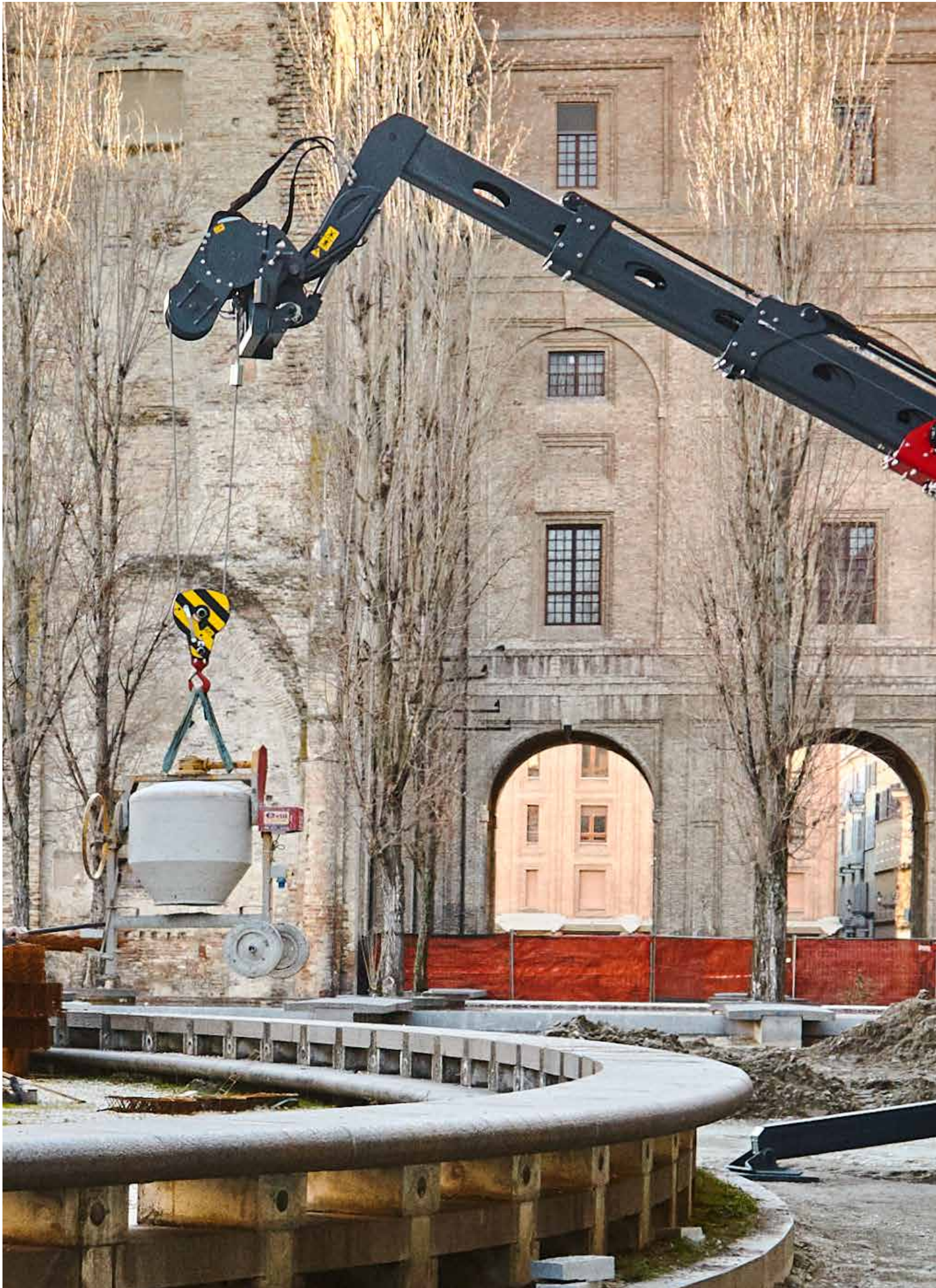



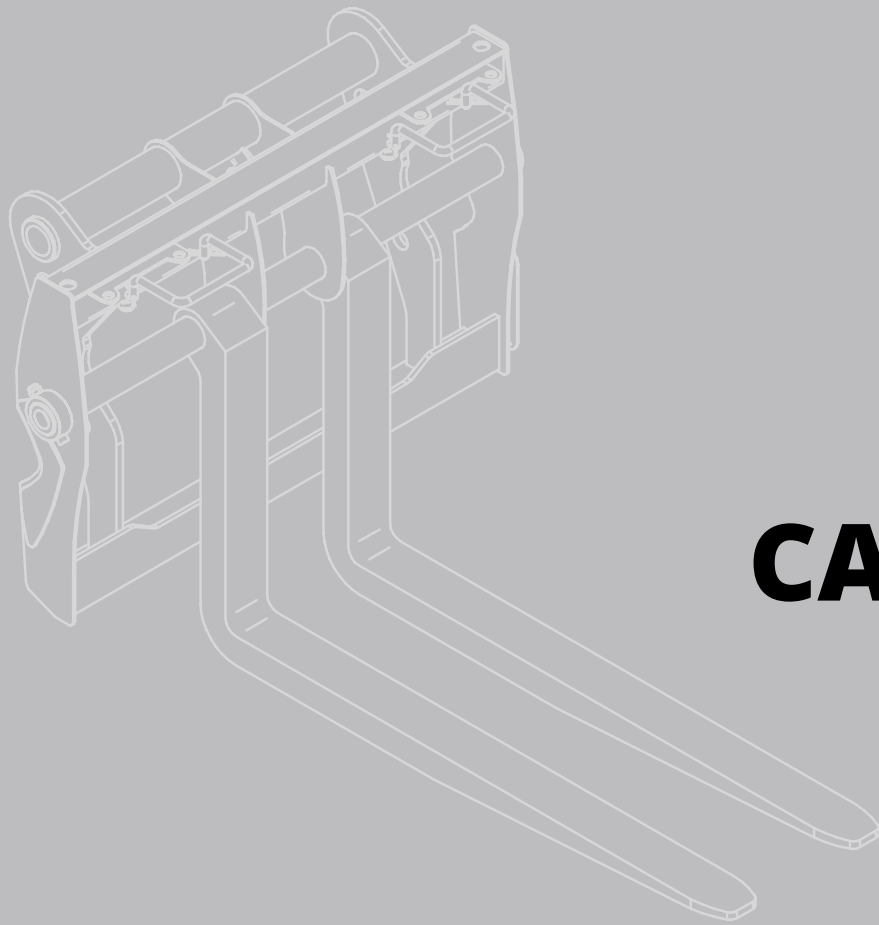

FORK CARRIAGES







STANDARD FORK CARRIAGE 5T

ATT - 03 - 001 Q-FIT I

Floating fork carriage with 5,000 kg capacity.

**Suitable for
RTH - TH**

FC5T

				
5,000 kg	1,200 mm	586 mm (min) - 1,040 mm (max)	✗	✓









FEM FORK CARRIAGE 5T

ATT - 03 - 003 Q-FIT I

Fork carriage with fork attachment plate, 5,000 kg capacity, 1,300 mm width

**Suitable for
RTH - TH
NO ANSI**

FCF5T 1,3

					
5,000 kg	1,200 mm	260 mm (min) - 1,300 mm (max)	✗	✗	✓



GRID FOR LOAD PROTECTION FOR FEM FORK CARRIAGE

ATT - 03 - 005

Upper support and protection grille for FEM type fork carriage.

**Suitable for
RTH - TH**

PCF



1,140 x 500 mm



GRID FOR LOAD PROTECTION FOR STD FORK CARRIAGE

ATT - 03 - 038

Upper support and protection grille for fork carriage.

**Suitable for
RTH - TH**

PC



1,070 x 356 mm

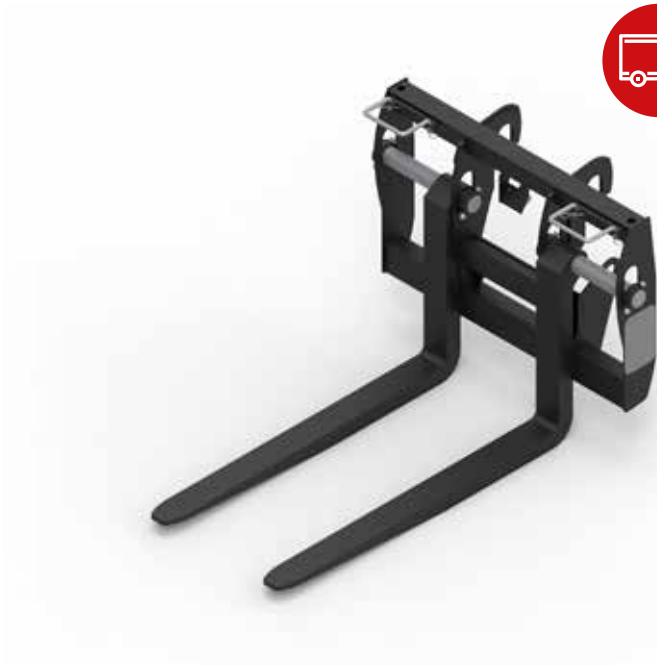

STANDARD FORK CARRIAGE 6T

ATT - 03 - 006 Q-FIT I

Floating fork carriage with 6,000 kg capacity.

**Suitable for
RTH - TH**

FC6T				
6,000 kg	1,200 mm	456 mm (min) - 1,040 mm (max)	✗	✓



STANDARD FORK CARRIAGE 6T

ATT - 03 - 008 Q-FIT I

Floating fork carriage with 6,000 kg capacity, dedicated for model RTH 6.46.

**Suitable for
RTH 6.46**

FC6T				
6,000 kg	1,200 mm	580 mm (min) - 1,040 mm (max)	✗	✓

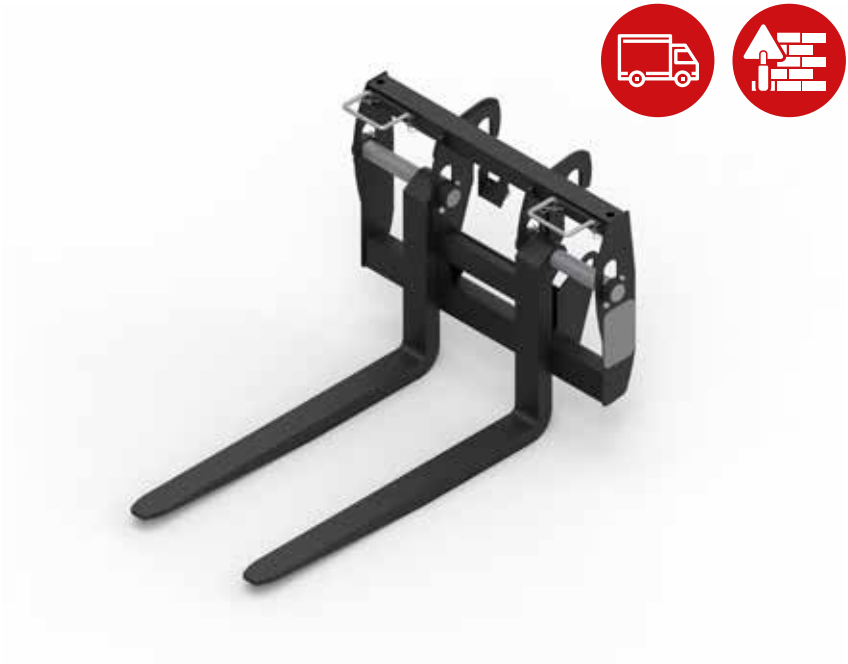

FORK CARRIAGE 6T

ATT - 03 - 009 Q-FIT I

Floating fork carriage with 6.000 kg capacity, increased width of 1,840 mm and minimum closure 1,550 mm.

Suitable for
RTH - HTH - TH

FC6T 6x5 FT

6,000 kg	1,550 mm	740 mm (min) - 1,840 mm (max)	×	×	✓



FEM FORK CARRIAGE 6T

ATT - 03 - 010 Q-FIT I

Forks with fork attachment plate, 6,000 kg capacity, 1,320 mm width and 1,200 mm fork length.

Suitable for
RTH - TH

FCF6T 1,3

6,000 kg	1,200 mm	280 mm (min) - 1,310 mm (max)	×	×	✓



STANDARD FORK CARRIAGE 6T

ATT - 03 - 012 *Q-FIT I*

Floating forks with 6,000 kg capacity.

**Suitable for
TH**

FC6T FIX

				
6,000 kg	1,200 mm	780 mm (min) - 1,040 mm (max)	✗	✓



WIDE FORK CARRIAGE 6T

ATT - 03 - 014 *Q-FIT I*

Floating forks with 6,000 kg capacity, dedicated for the TH range.

**Suitable for
TH**

FC6T 72x72 FIX

				
6,000 kg	1,830 mm	700 mm (min) - 1,840 mm (max)	✗	✓

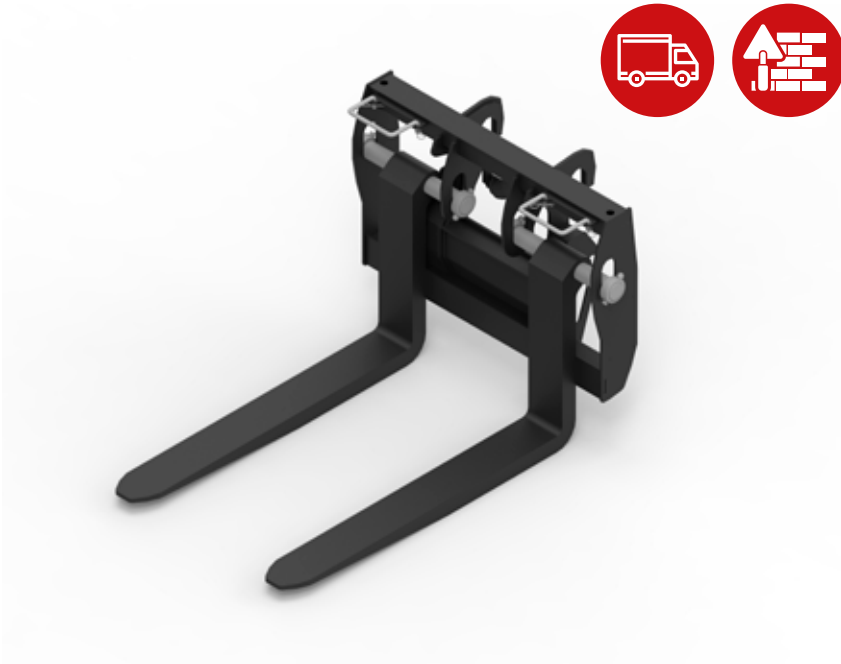

STANDARD FORK CARRIAGE 8T

ATT - 03 - 015 Q-FIT I

Floating forks with 8,000 kg capacity.

Suitable for RTH

FC8T					
8,000 kg	1,200 mm	580 mm (min) - 1,040 mm (max)	✗	✗	✓



WIDE FORK CARRIAGE 8T

ATT - 03 - 017 Q-FIT I

Floating fork carriage with 8,000 kg capacity, fork width 1,840 and fork length 1,830 mm.

Suitable for RTH - HTH

FC8T 72x72					
8,000 kg	1,830 mm	580 mm (min) - 1,840 mm (max)	✗	✗	✓









FORK CARRIAGE 10T

ATT - 03 - 018 *Q-FIT I*

Floating fork carriage with capacity up to 10,000 kg, with load protection grid.

**Suitable for
HTH**

F10T				
				
10,000 kg	1,500 mm	min 810 mm	max 1,750 mm	

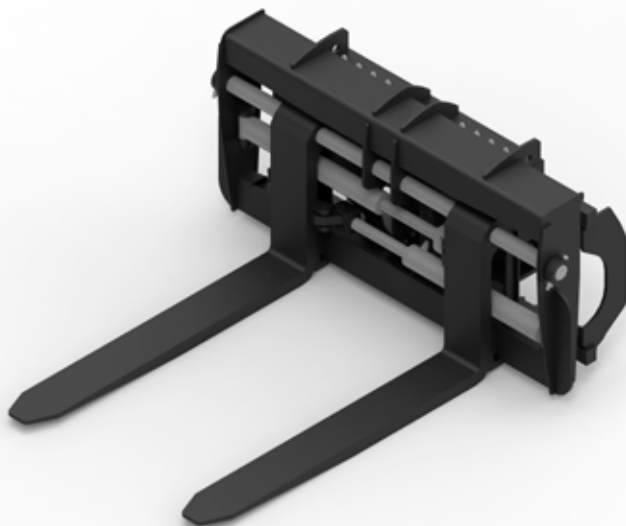

FORK CARRIAGE 10T (WITH FORK POSITIONER)

ATT - 03 - 019 *Q-FIT I*

Floating fork carriage with capacity up to 10,000 kg, with hydraulic movement of the individual forks possible.

**Suitable for
HTH**

FCP10T				
				
10,000 kg	1,500 mm	min 820 mm	max 1,740 mm	



FORK CARRIAGE 10T (WITH FORK POSITIONER)

ATT - 03 - 020 Q-FIT I

Fork carriage with capacity up to 10,000 kg, with hydraulic movement of the individual forks possible. Equipped with 2,500 mm long, 2,300 mm wide forks. Load protection grid included.

**Suitable for
HTH**

FCP10T 2,5 C

				
10,000 kg	2,500 mm	min 820 mm	max 2.310 mm	

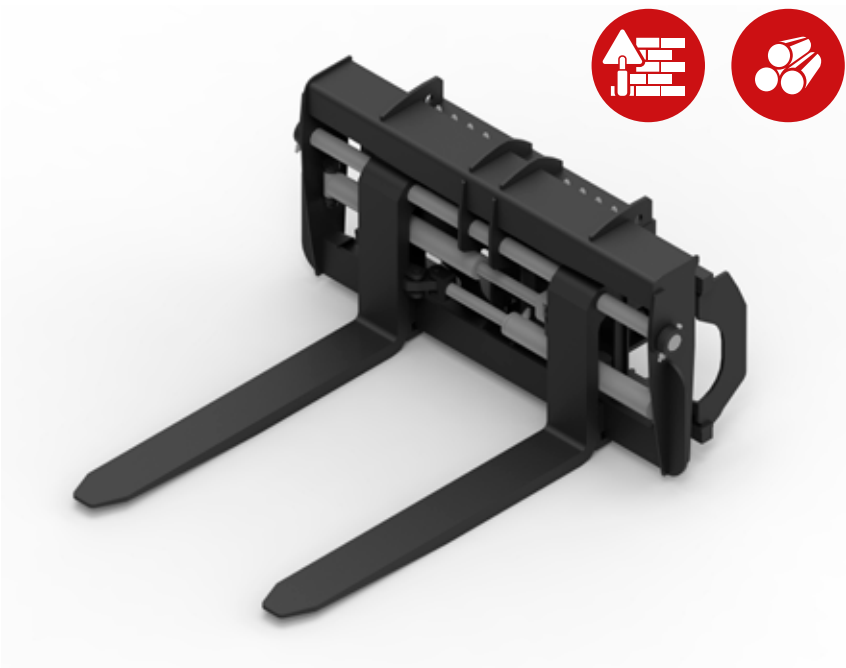



FORK CARRIAGE 10T (WITH FORK POSITIONER + SIDE SHIFT)

ATT - 03 - 036 Q-FIT I

Fork carriage with capacity up to 10,000 kg, with hydraulic movement of the individual forks and combined side shift possible.

**Suitable for
RTH - HTH - TH**

FCPT10T 1,5

				SIDE SHIFT	
10,000 kg	1,500 mm	574 mm	1,744 mm	+/- 300 mm	







FORK CARRIAGE 13T (WITH FORK POSITIONER)

ATT - 03 - 021 Q-FIT I

Floating fork carriage with capacity up to 13,000 kg.



**Suitable for
RTH**

FCP13T				
13,000 kg	1,500 mm	min 850 mm	max 1,780 mm	✓



FORK CARRIAGE 16T

ATT - 03 - 022 Q-FIT I

Floating fork carriage with capacity up to 16,000 kg.



**Suitable for
HTH**

F16T				
16,000 kg	1,500 mm	1,130 mm	2,000 mm	✓



FORK CARRIAGE 16T (WITH FORK POSITIONER)

ATT - 03 - 023 Q-FIT I

Floating fork carriage with capacity up to 16,000 kg, with hydraulic movement of the individual forks possible. Load protection grid included.



**Suitable for
HTH**

FCP16T

16,000 kg	1,500 mm	1,160 mm	2,000 mm	✓



FORK CARRIAGE 16T (WITH FORK POSITIONER AND SIDE SHIFT)

ATT - 03 - 024 Q-FIT I

Floating fork carriage with capacity up to 16,000 kg, with hydraulic movement of the individual forks and combined side shift possible. Load protection grid included.

**Suitable for
HTH**

FCPT16 2,4

				SIDE SHIFT	
16,000 kg	2,400 mm	min 570 mm	max 1,995 mm	+/- 300 mm	✓



FORK CARRIAGE 16T (WITH FORK POSITIONER)

ATT - 03 - 025 Q-FIT I

Floating fork carriage with 2,300 mm width and capacity up to 10,000 kg, with hydraulic movement of the individual forks possible. Load protection grid included.

**Suitable for
HTH**

FCP16T C				
16,000 kg	2,400 mm	2,300 mm	1,268 - 2,300 mm	✓



FORK CARRIAGE 20T (WITH FORK POSITIONER)

ATT - 03 - 026 Q-FIT I

Floating fork carriage with capacity up to 20,000 kg, with hydraulic movement of the individual forks possible. Load protection grid included.

**Suitable for
HTH**

FCP20T				
20,000 kg	1,500 mm	1,160 mm	2,000 mm	✓



FORK CARRIAGE 24T (WITH FORK POSITIONER)

ATT - 03 - 027 Q-FIT I

Floating fork carriage with capacity up to 24,000 kg, with hydraulic movement of the individual forks possible. Load protection grid included.

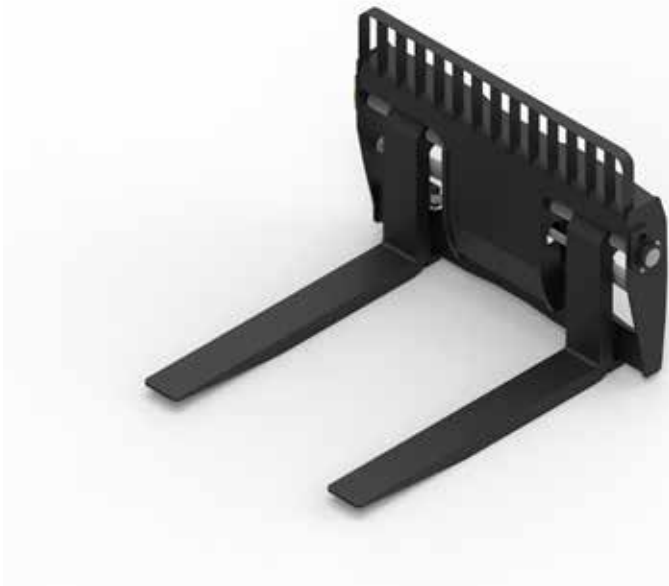

**Suitable for
HTH**

FCP24T

24,000 kg	1,800 mm	1,250 mm	1,990 mm	✓



FORK CARRIAGE 24T (WITH FORK POSITIONER)

ATT - 03 - 028 Q-FIT I

Floating fork carriage with capacity up to 24,000 kg. Fork width 2,315 mm, fork length 2,400 mm. Hydraulic movement of the individual forks possible. Load protection grid included.



**Suitable for
HTH**

FCP24T 2,4

24,000 kg	2,400 mm	2,315 mm	1,235 mm	✓



FORK CARRIAGE 27T (WITH FORK POSITIONER)

ATT - 03 - 029 Q-FIT I

Floating fork carriage with capacity up to 27,000 kg. Fork width 2,500 mm, fork length 2,400 mm. Hydraulic movement of the individual forks possible. Load protection grid included.

**Suitable for
HTH**

FCP27T				
27,000 kg	2,400 mm	1,430 mm	2,400 mm	✓



FORK CARRIAGE 30T (WITH FORK POSITIONER)

ATT - 03 - 030 Q-FIT I

Floating fork carriage with capacity up to 30,000 kg. Fork width 2,500 mm, fork length 2,400 mm. Hydraulic movement of the individual forks possible. Load protection grid included.

**Suitable for
HTH**

FCP30T				
30,000 kg	2,400 mm	min 1,360 mm	max 1,990 mm	✓



FORK CARRIAGE 30T (WITH FORK POSITIONER AND SIDESHIFT)

ATT - 03 - 031 Q-FIT I

Lowered fork carriage with capacity up to 30,000 kg, with hydraulic movement of the individual forks and combined side shift possible. Thinner forks and without load protection and support grille.

**Suitable for
HTH**



FCPT30T 2,4 R

				SIDE SHIFT	
30,000 kg	2,400 mm	min 830 mm	max 2,650 mm	+/- 300 mm	✓



EXTENDABLE 30T FORK CARRIAGE WITH POSITIONER

ATT - 03 - 032 Q-FIT I

Lowered fork carriage with capacity up to 30,000 kg, with hydraulic movement of the individual forks possible.

**Suitable for
HTH**

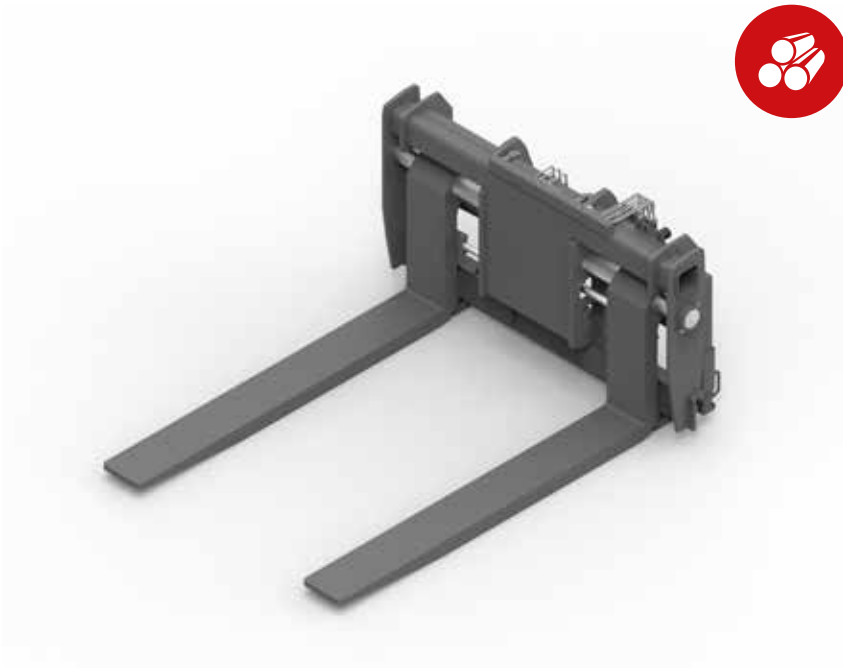

FCEP30T 2,4 R

30,000 kg	2,400 mm	1,360 mm	max 2,500 mm	✓



FORK CARRIAGE 35T (WITH POSITIONER)

ATT - 03 - 033 Q-FIT I

Fork carriage with capacity up to 35,000 kg, with hydraulic movement of the individual forks possible.

**Suitable for
HTH**

FCP35T

35,000 kg	2,400 mm	min 1,400 mm	max 2,030 mm	✓



FORK CARRIAGE 50T (WITH POSITIONER)

ATT - 03 - 037 Q-FIT I

Fork carriage with capacity up to 50,000 kg, with hydraulic movement of the individual forks. Load protection grid included.

**Suitable for
HTH**

FCP50T

50,000 kg	2,400 mm	1,400 mm	2,030 mm	✓









ROTATING 2,5T FORK CARRIAGE

ATT - 03 - 034 Q-FIT I

Retracting rotating forks which allow complete 360° rotation. These tough forks can lift and move all kinds of materials, pallets and long boards up to a maximum of 2,500 kg, in the smallest possible space and in all directions. With practical dovetails for improved positioning and fastening of the forks in their seat. Equipped with a rotation block which can limit the rotation to +/- 90°.

**Suitable for
RTH - TH**

RFC 2,5				
				
2,500 kg	1,200 mm	1,120 mm	+/- 90°	





JIB WITH & WITHOUT WINCH



JIB 600KG

ATT - 04 - 001 Q-FIT I

Fixed-hook jib which increases reach by a further 4 metres. Tubular structure to improve the weight/capacity ratio.



Adatto per RTH

J600		
600 kg	4,000 mm	✓



JIB 800KG FOR WINCH AT THE LOWER END OF THE BOOM

ATT - 04 - 003 Q-FIT I

Specific jib for machine equipped with winch at the base of the boom. Tubular structure to improve the weight/capacity ratio and to increase the working range.

Winch at the lower end of the boom is not included and must be ordered separately.



Suitable for RTH

JV 800					
800 kg	7,200 mm	12 mm	77 m	16 m/min	✓



JIB WITH WINCH 800KG

ATT - 04 - 005 Q-FIT I

Jib, length 7 metres, with integrated winch on attachment. Tubular structure to improve the weight/capacity ratio. Winch equipped with rope pressure roller and hydraulic limit switch system for rope raising/lowering.



Suitable for
RTH - TH

JW800

					
800 kg	7,100 mm	10 mm	24/44 m	48/24 m/min	✓



JIB WITH WINCH 800/1,500 KG





ATT - 04 - 007 Q-FIT I

Jib with integrated winch on attachment which can be folded and configured for two capacities. Fully extended, with length of 7 metres, it has a single capacity of 800 kg; folded, with 3.3 metre length, it has a dual capacity of 1,500 kg. Winch equipped with rope pressure roller and hydraulic limit switch system for rope raising/lowering.



Suitable for
RTH - TH - HTH 10.10

JW 800/1500

					
800/1,500 kg	7,100 / 3,300 mm	10 mm	44/24 m	48/24 m/min	✓



JIB WITH WINCH 1,200/3,000KG

ATT - 04 - 009 Q-FIT I

Jib with integrated winch on attachment which can be folded and configured for two capacities. Fully extended, with length of 4.5 metres, it has a single capacity of 1,200 kg; folded, with 1.6 metre length, it has a dual capacity of 3,000 kg. Winch equipped with rope pressure roller and hydraulic limit switch system for rope raising/lowering.



Suitable for
RTH - TH - HTH 10.10

JW1200/3000

1,200/3,000 kg	4,500 / 1,600 mm	10 mm	48/25 m	48/24 m/min	✓



JIB WITH WINCH 1,500KG

ATT - 04 - 011 Q-FIT I

Jib with integrated winch on attachment, capacity 1,500 kg and length 2 metres. Tubular structure to improve the weight/capacity ratio. Winch equipped with rope pressure roller and hydraulic limit switch system for rope raising/lowering.



Suitable for
RTH - TH

JW 1500

1,500 kg	2,200 mm	10 mm	24 m	52 m/min	✓







JIB 2,000KG

ATT - 04 - 013 Q-FIT I

Dual T-section beam with fixed hook, capacity 2,000 kg and length 2.7 metres

Suitable for
RTH - TH

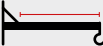
J2000

		
2,000 kg	2,700 mm	✓



JIB WITH WINCH 2,000KG

ATT - 04 - 015 Q-FIT I

Jib with integrated winch on attachment, capacity 2,000 kg and length 2 metres. Tubular structure to improve the weight/capacity ratio. Winch equipped with rope pressure roller and hydraulic limit switch system for rope raising/lowering.

Suitable for
RTH - TH

JW 2000

					
2,000 kg	2,150 mm	10 mm	24 m	24 m/min	✓



JIB WITH WINCH 2,700KG

ATT - 04 - 017 Q-FIT I

Jib with integrated winch on attachment, capacity 2,700 kg and length 1.7 metres. Tubular structure to improve the weight/capacity ratio. Winch equipped with rope pressure roller and hydraulic limit switch system for rope raising/lowering.

**Suitable for
RTH - TH**

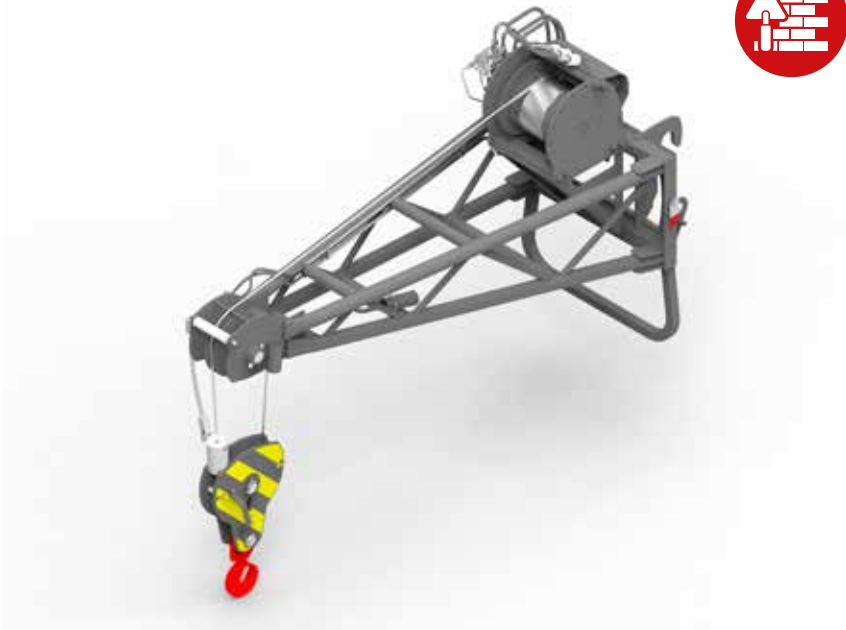

JW2700

					
2,700 kg	1,700 mm	12 mm	50 m	30 m/min	✓





JIB WITH WINCH 3,000KG

ATT - 04 - 019 **Q-FIT I**

Jib with integrated winch on attachment, capacity 3,000 kg and length 1.7 metres. Tubular structure to improve the weight/capacity ratio. Winch equipped with rope pressure roller and hydraulic limit switch system for rope raising/lowering.

**Suitable for
RTH - TH**

JW 3000

					
3,000 kg	1,700 mm	12 mm	50 m	30 m/min	✓







TELESCOPIC JIB 2,500/1,500KG

ATT - 04 - 021 **Q-FIT I**

Telescopic box-section jib with fixed hook. Two capacities: fully retracted 2,500 kg at 1,800 mm; extended 1,500 kg at 2,700 mm, with travel of 900 mm.

**Suitable for
RTH - TH**

JT2500

			
2,500 kg (closed) - 1,500 kg (opened)	1,790 mm (closed) - 2,690 mm (opened)	900 mm	✓



3,000KG "SWAN NECK" JIB



ATT - 04 - 023 Q-FIT I

Swan-neck jib with 3,000 kg capacity, ideal for working in confined spaces and under roof, overhangs and greenhouses.



Suitable for
RTH - TH - HTH 10.10

JCC3000

			
3,000 kg	1,500 mm	1,077 mm	✓







HOOKS



HOOK 6T

ATT - 05 - 001 **Q-FIT I**

Type-approved hook for swivel lifting with latch, high-strength alloy steel. Capacity up to 6,000 kg. Metal storage support included in code.

Suitable for
RTH - TH - HTH 10.10

H6

			
6,000 kg	500 mm	✓	✓





HOOK 8T

ATT - 05 - 003 **Q-FIT I**

Type-approved hook for swivel lifting with latch, high-strength alloy steel. Capacity up to 8,000 kg. Metal storage support included in code.

Suitable for
RTH - TH - HTH 10.10

H8

			
8,000 kg	1,102 mm	✓	✓



HOOK 10T

ATT - 05 - 005 Q-FIT I

Type-approved hook for swivel lifting with latch, high-strength alloy steel. Capacity up to 10,000 kg. Metal storage support included in code.

Suitable for
RTH - TH - HTH 10.10

H10

			
10,000 kg	500 mm	✓	✓



HOOK 13T

ATT - 05 - 013 Q-FIT I

Type-approved hook for swivel lifting with latch, high-strength alloy steel. Capacity up to 13,000 kg. Compact design to increase performance during loading in terms of the stability of the load.

Suitable for
RTH - HTH

H13

			
13,000 kg	297 mm	✓	✓



HOOK 16T



ATT - 05 - 007 Q-FIT I

Type-approved hook for swivel lifting with latch, high-strength alloy steel. Capacity up to 16,000 kg Metal storage support included in code. Compact design to increase performance during loading in terms of the stability of the load.



**Suitable for
HTH**

H16S

			
16,000 kg	350 mm	✓	✓



HOOK 20T

ATT - 05 - 008 Q-FIT I

Type-approved hook for swivel lifting with latch, high-strength alloy steel. Capacity up to 20,000 kg Metal storage support included in code. Compact design to increase performance during loading in terms of the stability of the load.



**Suitable for
HTH**

H20S

			
20,000 kg	350 mm	✓	✓



HOOK 30T

ATT - 05 - 009 Q-FIT I

Oscillating lifting hook to facilitate load positioning. Capacity up to 30,000 kg. Compact design to increase performance during loading in terms of the stability of the load.



**Suitable for
HTH**

H30S

			
30,000 kg	400 mm	+/- 30°	✓



HOOK 40T

ATT - 05 - 010 Q-FIT I

Oscillating lifting hook to facilitate load positioning. Capacity up to 40,000 kg. Compact design to increase performance during loading in terms of the stability of the load.

**Suitable for
HTH**

H40

			
40,000 kg	1,200 mm	+/- 30°	✓



SHORT HOOK 40T

ATT - 05 - 011 Q-FIT I

Oscillating lifting hook to facilitate load positioning. Capacity up to 40,000 kg. Compact design to increase performance during loading in terms of the stability of the load.

**Suitable for
HTH**

H40S

			
40,000 kg	400 mm	+/- 30°	✓



HOOK 50T

ATT - 05 - 012 Q-FIT I

Oscillating lifting hook to facilitate load positioning. Capacity up to 50,000 kg. Compact design to increase performance during loading in terms of the stability of the load.

**Suitable for
HTH**

H50

			
50,000 kg	760 mm	+/- 30°	✓



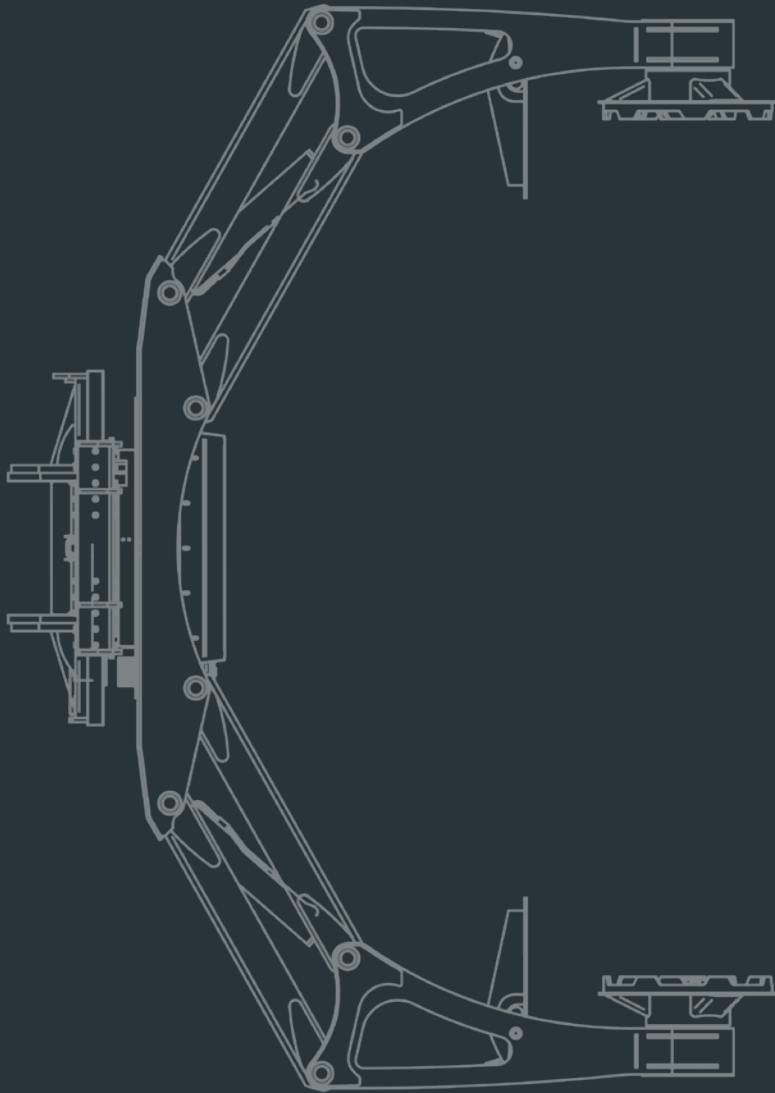

CLAMPS



RIB HANDLER 4T

ATT - 06 - 001 Q-FIT I

Clamp made of high-strength material for positioning the ribs comprising the supporting arches for tunnel construction.

Suitable for
RTH - HTH - TH

RC 4T

4,000 kg	46°	+/- 65° (manual)	✓



TYRE HANDLER 2.5T

ATT - 06 - 003 Q-FIT I

Tyre clamp, 2,500 kg capacity, for 25" tyres. Hydraulic opening/closing.

⚠ OPT-02-022 DOUBLE HYDRAULIC OUTPUT AT THE BOOM HEAD IS MANDATORY

Suitable for
RTH - TH - HTH 10.10

TC2,5.25

2,500 kg	1,220 mm	2,350 mm	360°	✗	✓





TYRE HANDLER 3.5T







ATT - 06 - 004 Q-FIT I

Tyre clamp, 3,500 kg capacity, for 35" tyres. Hydraulic opening/closing. Clamp rotation (clockwise/anticlockwise): +/- 24°; tyre rotation +/- 61°.



**Suitable for
HTH 10.10**

TC3,5

					
3,500 kg	1,120 mm	3,500 mm	+/- 24°	+/- 61°	✓



TYRE HANDLER 3.8T

ATT - 06 - 005 Q-FIT I

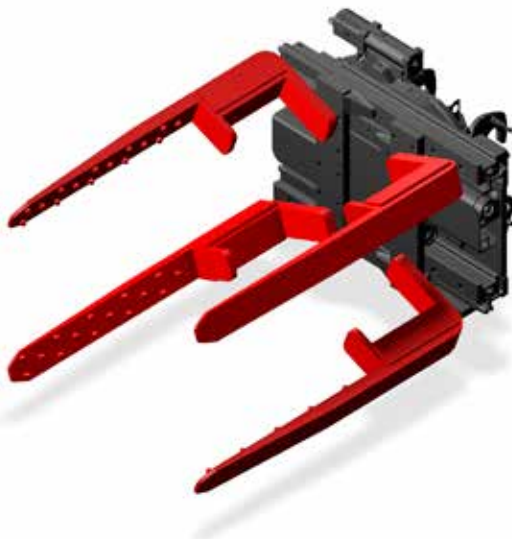

Tyre clamp, 3,800 kg capacity, for 49" tyres. Hydraulic opening/closing and 360° rotation.



⚠ OPT-02-022 DOUBLE HYDRAULIC OUTPUT AT THE BOOM HEAD IS MANDATORY

**Suitable for
RTH - TH - HTH 10.10**

TC3,8.49

					
3,800 kg	1,210 mm	3,130 mm	360°	✗	✓



TYRE HANDLER 8T

ATT - 06 - 006 Q-FIT I

Tyre clamp, 8,000 kg capacity, for 63" tyres. Hydraulic opening/closing movement, 360° tyre rotation, +/- 300 mm lateral clamp movement, 344° clockwise/anticlockwise clamp rotation.



**Suitable for
HTH**

TC08.63

8,000 kg	1,180 mm	4,000 mm	344° (+165°/-179°)	360°	+/- 300 mm	✓



TYRE HANDLER 16T

ATT - 06 - 007 Q-FIT I

Tyre clamp, 16,000 kg capacity, for 63" tyres. Hydraulic opening/closing movement, 360° rotation, +/- 300 mm lateral clamp movement, 344° clockwise/anticlockwise clamp rotation. Tyre rotation of 360° performed via chains to provide additional safety.



**Suitable for
HTH**

TC16.63 CP

16,000 kg	1,170 mm	4,250 mm	344° (+165°/-179°)	360°	+/- 300 mm	✓



DEMOLITION GRAB

ATT - 06 - 008 *Q-FIT I*

Clamp used for primary demolition of reinforced concrete. The continuous hydraulic rotation facilitates positioning of the equipment, while the robust dual ball race slewing bearing ensures strength and increases safety. The cylinders develop enormous force which is then increased and transferred to the jaws (even completely open) by a unique mechanism. The special teeth profile maximises penetration, keeping the tips sharp for longer. The patented Speed-Valve increases productivity and protects the hydraulic system from peaks of pressure.

⚠ OPT-02-022 DOUBLE HYDRAULIC OUTPUT AT THE BOOM HEAD IS MANDATORY

⚠ OPT-03-005 MANDATORY PROTECTION GRID FOR WINDSHIELD

Suitable for
RTH - HTH

PD CR5

2,000 kg	450 mm	360°	✓



PIPES HANDLER 1,000 KG

ATT - 06 - 009 *Q-FIT I*

Clamp designed to move pipes, load capacity up to 1,000 kg, min. \varnothing 242 mm and max. 580 mm. The clamp has three degrees of freedom; 360° rotation, side shift and clamps opening/closing.



Suitable for
RTH - HTH 10.10

PC 1000

1,000 kg	242 mm	580 mm	+/- 150 mm	360°	✓



CYLINDER HANDLER 11T

ATT - 06 - 010 Q-FIT I

Clamp for the maintenance, replacement and movement of large excavator cylinders up to 11,000 kg and max \varnothing 620 mm. This attachment must be installed with MTM, which must be ordered separately.

⚠ ATT-08-004 MULTITool - HANDLER FOR MULTIPLE ATTACHMENTS IS MANDATORY

**Suitable for
HTH**



CC

11,000 kg	2,960 - 960 mm	5,800 mm (max) 2,760 mm (min)	620 mm	+/- 300 mm	360°	✓



CYLINDER HANDLER 4.5T

ATT - 06 - 011 Q-FIT I

Clamp for the maintenance, replacement and movement of large excavator cylinders up to 4,500 kg and max \varnothing 450 mm. Clamp side shift +/- 300 mm, 360° clockwise/anticlockwise clamp rotation, and +/- 27° cylinder rotation. This attachment is provided as standard with its support. Therefore, it is not necessary to purchase the Multi Tool Manipulator (ATT - 08 - 004).

**Suitable for
HTH 10.10**



CC 4.5

4,500 kg	4,420 - 2,290 mm	4,240 mm (max) 2,740 mm (min)	450 mm	+/- 300 mm	360°	+/- 27°	✓







BUCKETS





BUCKET 1,000L

ATT - 07 - 001 Q-FIT I

Heavy-duty bucket with blade, capacity 1,000 kg. Suitable for moving aggregates, sand, gravel and similar materials around site.

**Suitable for
RTH - TH**

CB 1000

			
1,000 l	800 l	2,450 mm	✓



BUCKET 2,000 L

ATT - 07 - 003 Q-FIT I

Heavy-duty bucket with blade, capacity 2,000 kg. Designed to facilitate loading and unloading of materials. Suitable for moving aggregates, sand, gravel and similar materials around site.

**Suitable for
HTH**

CB 2000

			
2,090 l	1,660 l	2,460 mm	✓



BUCKET 3,000L

ATT - 07 - 004 Q-FIT I

Heavy-duty bucket with blade, capacity 3,000 kg. Designed to facilitate loading and unloading of materials. Suitable for moving aggregates, sand, gravel and similar materials around site.

**Suitable for
HTH**

CB 3000

			
3,090 l	2,450 l	3,010 mm	✓



WASTE BUCKET 2,000 l

ATT - 07 - 007 Q-FIT I

Aggregates bucket with capacity up to 2,000 kg.

**Suitable for
RTH - TH**

BIM 2000

			
2,050 l	1,500 l	2,410 mm	✓

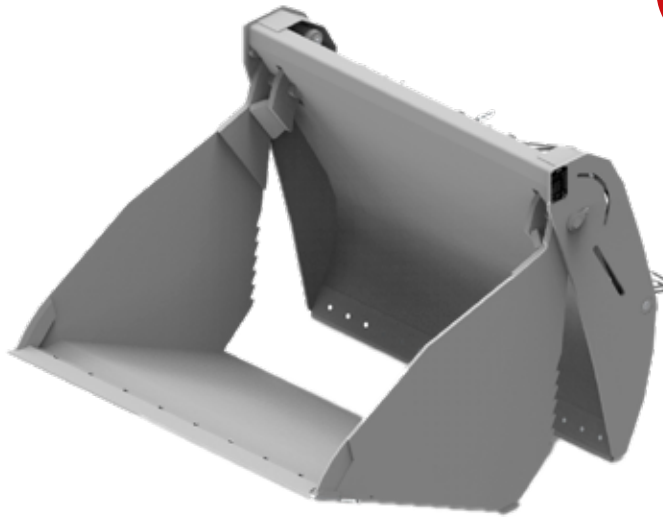





BUCKET 4X1 5,900 I

ATT - 07 - 006 Q-FIT I

Versatile four-in-one bucket for various site uses. Ideal for picking up material with density below $\leq 2.1 \text{ kg/m}^3$. Sides with teeth to ensure a safe grip on cylindrical objects. Rear blade for terrain levelling and recovery.

Suitable for
HTH

4X1 5900

			
5,900 l	4,715 l	2,500 mm	✓



BUCKET 4X1 850 I

ATT - 07 - 009 Q-FIT I

Bucket used for leveling and dumping by keeping the clamp closed and angling the shovel forward it will dig into the ground and the bucket will start to fill with material. Once the bucket is full we can load it directly into the dumper. The grading function enable the operator to lay out material to a required depth.

The depth can be varied by varying travelling speed or how gap the bucket is opened. Use the bucket to pick up materials or objects. Open the bucket and drive it over the object to clamp. Lower the bucket and safe close the bucket. Use the bucket as a bulldozer, you open up the clamp frame fully and by using the shovel frame allows the machine to push material forward a layer at a time.

Suitable for
RTH - TH

4X1 850L

			
850 l	550 l	2,300 mm	✓



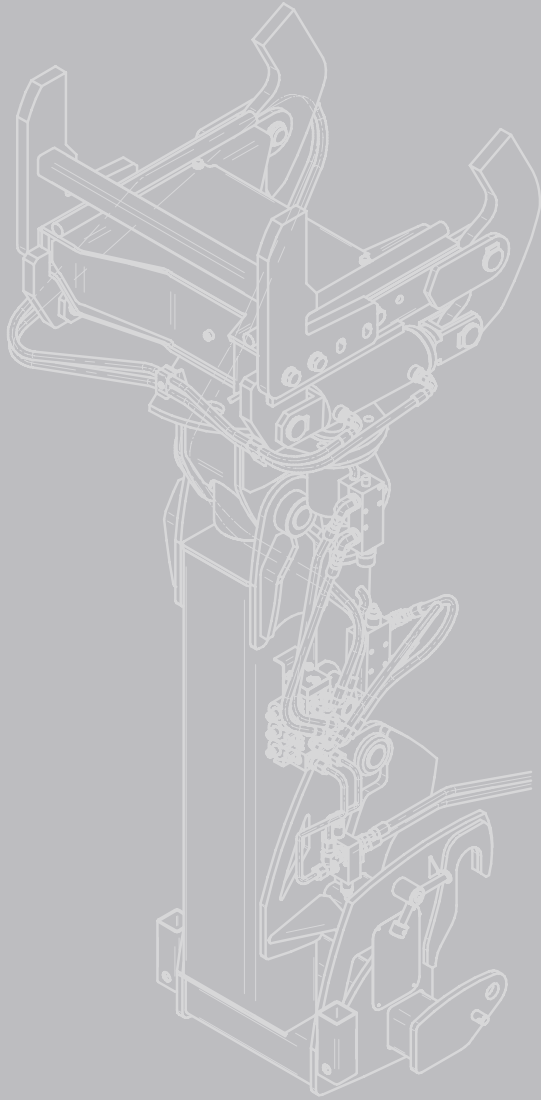

SPECIALS



TREE CUTTER

ATT - 08 - 001 Q-FIT I

This grapple saw is the ideal solution for cutting down special trees. Spring suspension system for saw. Inclination function during the cutting process which prevents the saw from being damaged. Cutting diameter up to 75 cm.

⚠ OPT-05-001 PRE ARRANGEMENT FOR TREE CUTTING DEVICE

⚠ OPT-05-005 BOOM PROTECTION FOR TREE CUTTING DEVICE AND DUSTY ENVIRONMENTS IS MANDATORY

**Suitable for
RTH - TH**

TREE CUTTER

1,280 mm	360°	✓

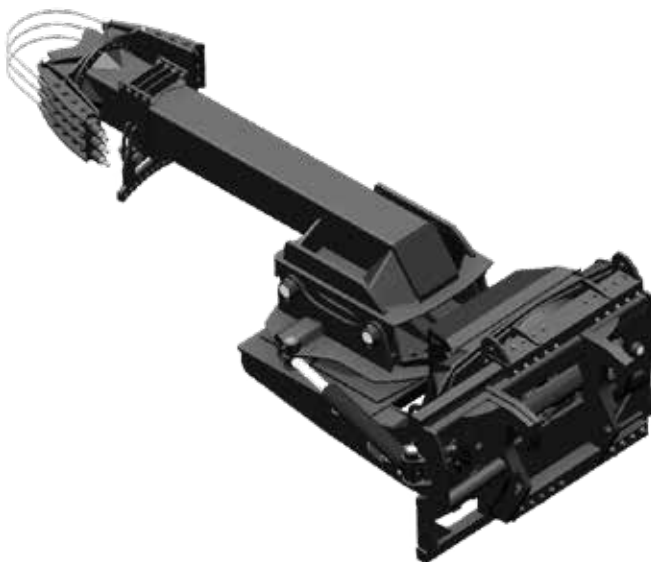

SUSPENSION CYLINDERS TOOL

ATT - 08 - 002 Q-FIT I

Accessory specially designed for the safe removal of the suspension and front gearbox of dumpers.

⚠ ATT-08-004 MULTITOOL - HANDLER FOR MULTIPLE ATTACHMENTS IS MANDATORY

**Suitable for
HTH**

SCT

Hub + suspension: 9,000 kg Only suspension: 7,000 kg	2,962 mm	60°	360°	360°	+/- 300 mm	Without adapter: 370 - 530 mm With adapter: 250 - 400 mm	✓





WHEEL HUB TOOL

ATT - 08 - 003 Q-FIT I

Accessory specially designed for the safe removal of the rear gearmotor of dumpers.

⚠ ATT-08-004 MULTITOOL - HANDLER FOR MULTIPLE ATTACHMENTS IS MANDATORY

**Suitable for
HTH**

RWHT

<p>22,000 kg</p>	<p>842 - 1,322 mm</p>	<p>+/- 30°</p>	<p>✓</p>



MULTITOOL - HANDLER FOR MULTIPLE ATTACHMENTS

ATT - 08 - 004 Q-FIT I

Support designed for the use of the following attachments: CC, SCT and RWHT.

**Suitable for
HTH**



VACUUM MASTER

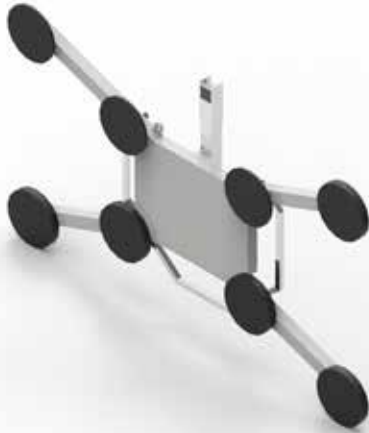

ATT - 08 - 007



Vacuum Master is the ideal accessory for safely moving pieces of glass in outdoor environments. It allows loads of up to 600 kg to be lifted in the horizontal and vertical position. The pieces can be rotated by 90° in one plane and 360° in another, and held at 45° increments. This allows for perfect alignment of the glass components and their insertion in the façade. Thanks to its modular structure, the lifting device can be perfectly adapted to the dimensions of the part. An LED indicator provides information on the charge status of the 12 V battery, which is rechargeable and replaceable. The regulated vacuum pump ensures constant operational availability for up to 8 hours.

Suitable for
RTH - TH

VACUUM MASTER

CAPACITY	N° SUCTION CUPS	Ø SUCTION CUPS	LIFTING CAPACITY	BATTERY	BATTERY POWER	WORKING TEMPERATURE	
600 kg	8	300 mm	75 kg/aspiration plate	12 V / 4 A	7 Ah	0°C a 40°C	



CONCRETE MIXER 700 I

ATT - 08 - 014 Q-FIT I

The concrete bucket is equipped with bottom and helix made of wear resistant steel HB400, fixed safety rounded grill with bag breaker, electric valve, hydraulic hoses, electric connection kit., hydraulic opening of the bottom through a cylinder with covered rod and unloading pipe.

 **OPT-02-022** DOUBLE HYDRAULIC OUTPUT AT THE BOOM HEAD IS MANDATORY

Suitable for
RTH - TH

MB 700 SL

CLASS	WIDTH	CAPACITY	TRANSMISSION	WEIGHT UNLADEN	
3	2,090 mm	700 lt	chain	765 kg	



RECYCLING PAPER CLAMP

ATT - 08 - 018 Q-FIT I

Clamp designed for the recycling industry, heavy logistics and the paper / cellulose supply chain. Designed to ensure maximum visibility of the frame from all angles. The excellent profile of the arms allows good functionality without compromising resistance. The section of the frame is made of steel, the arm bar in extruded steel alloy and the bases of the cast iron arms therefore a guarantee of durability and reliability. The built-in hydraulic flow distributors and the bidirectional pressure regulating valve regulate a fast and synchronized movement of the arms.

Suitable for
RTH - HTH - TH

PAPER CLAMP

CAPACITY AT BARYCENTER	FRAME WIDTH	FRAME HEIGHT	OPENING INTERNAL - INTERNAL	CLAMP	CLAMP THICKNESS	MINIMUM TROLLEY PLATE	HYDRAULIC FUNCTION
3,200 kg @500 mm	1,250 mm	751 mm	700 - 2,300 mm	550 x 750 mm	Fixed 78 mm	811 mm	2









TOOL FOR CONVEYOR BELT MAINTENANCE UP TO 25T

ATT - 08 - 008 Q-FIT I

Attachment that facilitates the replacement of conveyor belt belts. The attachment has two stabilization feet to be used during the unwinding / winding phase and a hydraulically removable column to allow you to grab or release the drum centered on the motorized washers. It is possible to move a drum on which the belt is wound up to 4m in diameter and 2.25m in length, with a capacity of up to 25t.

Suitable for
HTH 35.12/50.14

CBR

				
25,000 kg	1,192,5 - 2,842,5 mm	4,449 - 6,914 mm	360°	

SNOW BLADE

ATT - 08 - 009 Q-FIT I

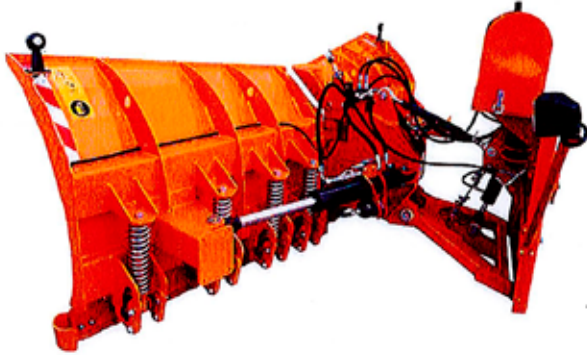

Snow plough attachment featuring steel load-bearing structure and quick-coupling counterplate to DIN 76060/A, or alternatively a three-point coupling structure for front three-point hitches as typically found on agricultural machinery. Front wing made from two 100% steel sections. Scraper blade with six independent sections in wear-resistant steel. Impact mitigation system featuring steel springs with adjustable force on each individual sector of the scraper blade. These flex backwards (against the direction of travel) in the event of a collision. Powder-coated steel load-bearing structure, with special rustproofing treatment and RAL 2011 (orange) final enamelling. Black HDPE wing.

Overpressure valve to damp lateral impacts, R2 piping with unified quick fittings and couplings. The transformable LTL blade can be set in a wedge position, inclined blade facing to the left or right, or inverse wedge (spoon shaped).

Suitable for
HTH 16.10/27.11

SNOW BLADE

ATTACHMENT WEIGHT	HEIGHT IN THE CENTER	HEIGHT EXTERNAL SIDE	WORKING WIDTH	MAX. WIDTH WHILE MOVING	
900 kg	980 mm	1,150 mm	3,47 mt	4,00 mt	



CONCRETE BUCKET 600 I

ATT - 08 - 010 Q-FIT I



Concrete bucket, capacity 600 l, with opening via hydraulic piston.

Suitable for
RTH - TH

BB600

					
600 l	1,420 mm	2,020 mm	1,180 mm	1,130 mm	



CONCRETE BUCKET 800 l

ATT - 08 - 019 **Q-FIT I**

Concrete bucket, capacity 800 l, with opening via hydraulic piston.

Suitable for
RTH - TH

BB800

800 l	1,500 mm	2,275 mm	1,500 mm	1,130 mm	X



CONCRETE BUCKET 1000 l

ATT - 08 - 020 **Q-FIT I**

Concrete bucket, capacity 1000 l, with opening via hydraulic piston.

Suitable for
RTH - TH

BB1000

1,000 l	1,620 mm	2,395 mm	1,500 mm	1,130 mm	X

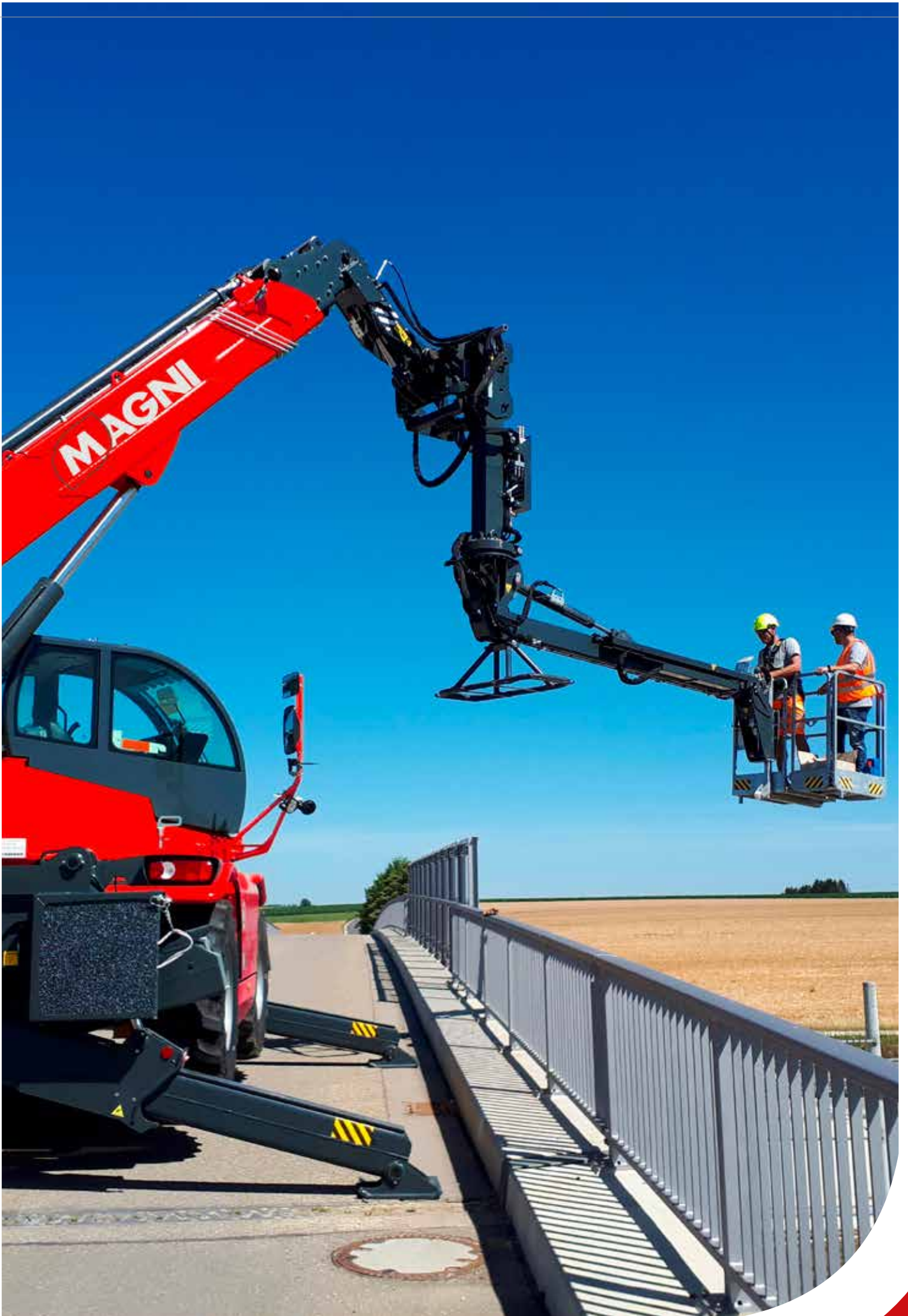



HANDLING AND DEMOLITION GRAPPLE



ATT - 08 - 011 Q-FIT I

Material loading bucket with reinforced structure to ensure safe, solid loading. Rotation: 360°; opening: 1,685 mm.

OPT-02-022 DOUBLE HYDRAULIC OUTPUT AT THE BOOM HEAD IS MANDATORY

Suitable for
RTH - HTH - TH

BM 120

			
2,000 kg	1,685 mm	360°	✓



COILS HANDLER 30T (SPUR)

ATT - 08 - 012 Q-FIT I

Attachment designed specifically for moving large steel coils in heavy industry. Equipped with leveling indicator and an extra translation +/- 300 mm to facilitate logistics operations.

Suitable for
HTH

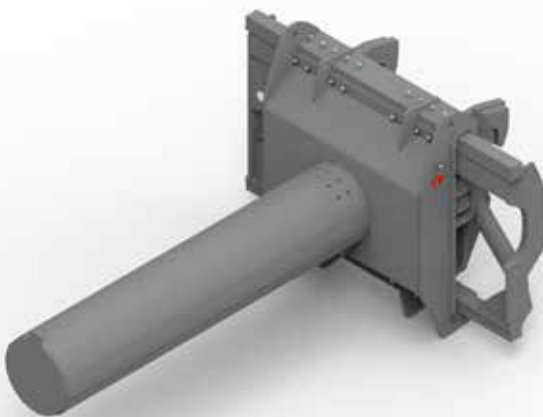

SCT30T

			
30,000 kg	2,015 mm	+/- 300 mm	✓



COILS HANDLER 22T (CLAMP)



ATT - 08 - 013 Q-FIT I

Attachment designed specifically for moving large steel coils in heavy industry, with diameters from 1,200 mm up to 1,600 mm. Pin inclination +/- 90° and pin side shift +/- 300 mm.



**Suitable for
HTH**

CH22T

	 MAX	 MIN			
22,000 kg	1,600 mm	1,200 mm	+/- 90°	+/- 300 mm	



AIRCRAFT TURBINE ENGINE HANDLER





ATT - 08 - 015 Q-FIT I

Accessory that allows to move turbocharged fan engines of aircraft (with a 4.8 t capacity). The accessory has four floating attachment points to allow easy attachment to the turbo fan. The support of the attachment points can rotate vertically 360° and horizontally (+/- 20°). There is also a translator with an excursion of +/- 300 mm. It can be coupled with HTH from 16 t up.



**Suitable for
RTH - HTH**

TFEH 4,6 T

	 MAX	 MIN	VERTICAL ROTATION	HORIZONTAL ROTATION	SIDE SHIFT	
4,600 kg	1,600 mm	1,200 mm	+/- 20°	360°	+/- 300 mm	

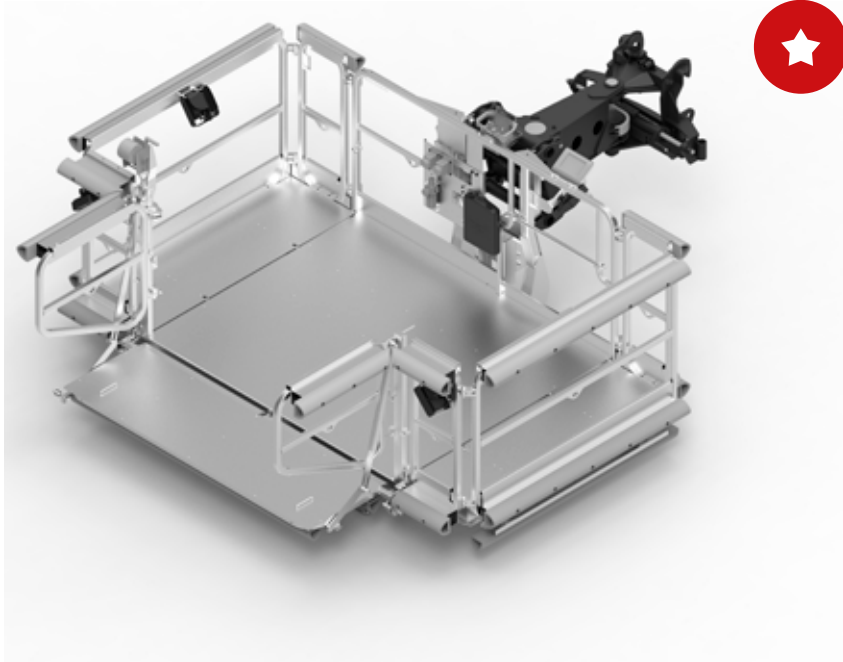

AIRCRAFT MAINTENANCE PLATFORM (WITH PROXIMITY SENSORS)

ATT - 08 - 016 Q-FIT I

Platform equipped with two 110 V - 50 Hz electrical outlets and a connection for compressed air on board. The entire platform is lined with non-marking rubber. It is also equipped with 2 cameras installed in the lower part of the platform for complete visibility once in height. The maneuvering area is visible on the display mounted on the basket. Important anti collision system on board which thanks to n. 9 sensors arranged along the perimeter of the basket limits movements when running a minimum safety distance from an obstacle. The anti-collision system thus begins to slow down the movements until it stops completely when the part is close to impact. The maneuvering area is always visible on the display.



⚠️ OPT-05-008 PRE ARRANGEMENT FOR AIRCRAFT MAINTENANCE PLATFORMS (RTH 7.26) - not included

⚠️ OPT-05-009 PRE ARRANGEMENT FOR AIRCRAFT MAINTENANCE PLATFORMS (RTH 6.25) - not included

Suitable for RTH - TH

RRP 10.2,5 - 3,5

1,000 kg	2,780 x 3,700 mm	+/- 90°	3	✓



AIRCRAFT MAINTENANCE PLATFORM (WITH PROXIMITY SENSORS) WITH WINCH 600KG

ATT - 08 - 017 Q-FIT I

Platform equipped with two 110 V - 50 Hz electrical outlets and a connection for compressed air on board. The platform is equipped with a winch with a capacity of up to 600 kg. The entire platform is lined with non-marking rubber. It is equipped with 2 cameras installed in the lower part of the platform for complete visibility once in height. The maneuvering area is visible on the display mounted on the basket. Important anti collision system on board which thanks to n. 9 sensors arranged along the perimeter of the basket limits movements when running a minimum safety distance from an obstacle. The anti-collision system starts to slow down the movements until it stops completely when the part is close to impact. The maneuvering area is always visible on the display.

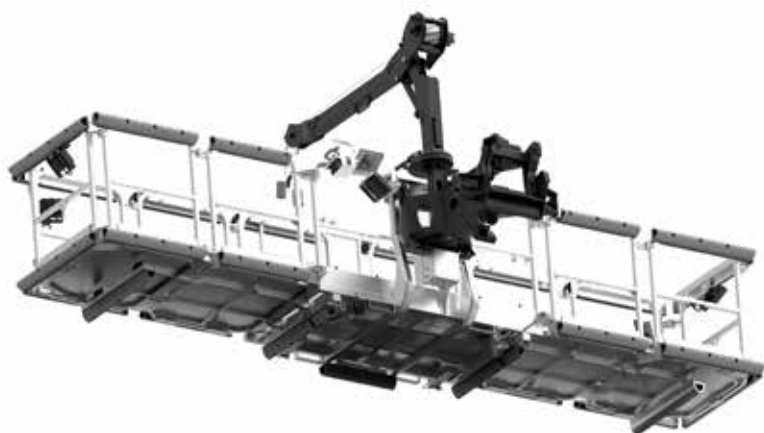

⚠ OPT-05-008 PRE ARRANGEMENT FOR AIRCRAFT MAINTENANCE PLATFORMS (RTH 7.26) - not included

⚠ OPT-05-009 PRE ARRANGEMENT FOR AIRCRAFT MAINTENANCE PLATFORMS (RTH 6.25) - not included

**Suitable for
RTH - TH**

REP 5.2 - 6.5 W0,6

500 kg	2,580 x 6,700 mm	+/- 90°	3	600 kg	2,015 mm	+ / - 90° manual	0° /64°	✓



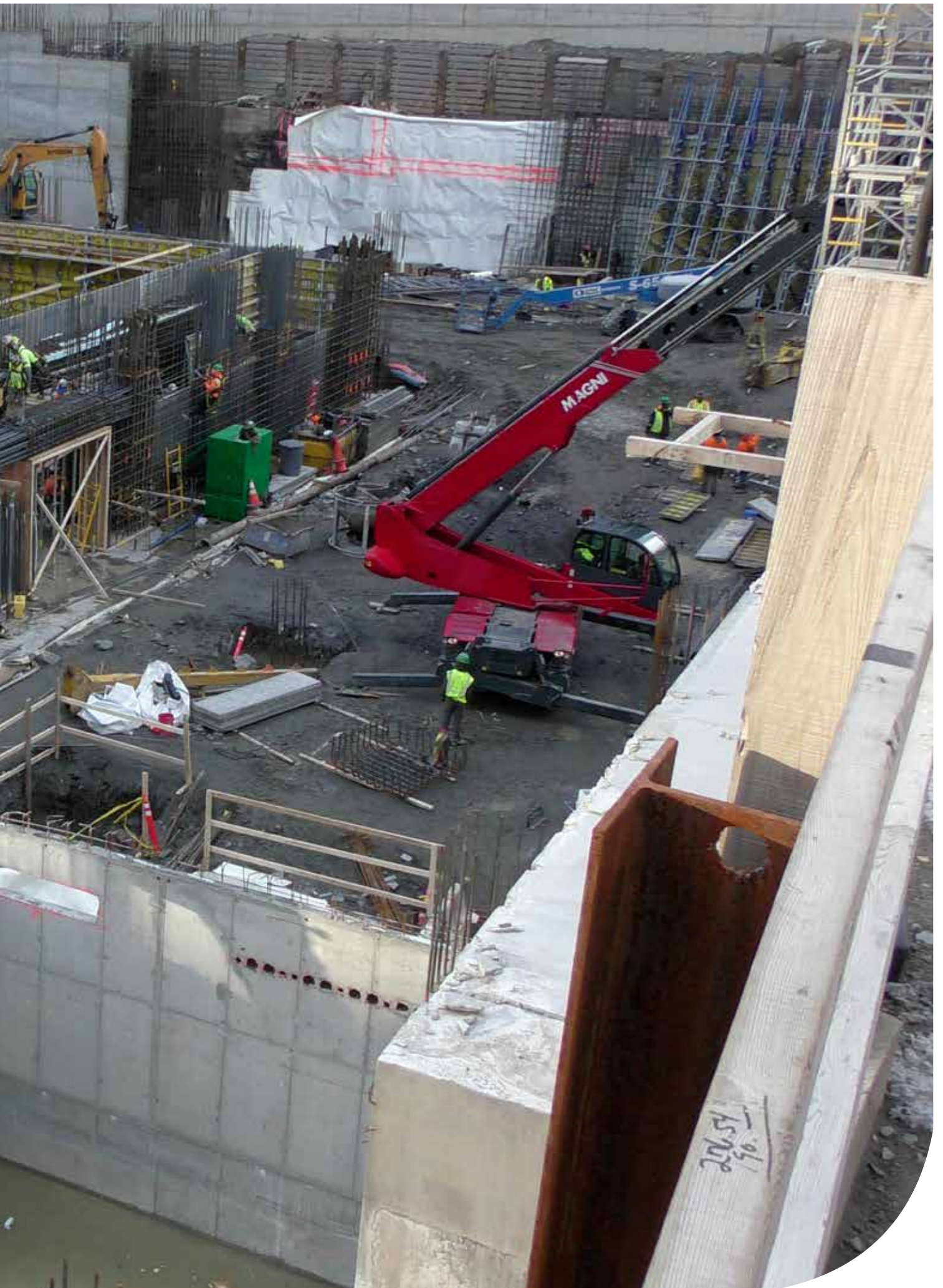

ALPHABET INDEX

CODE	PRODUCT	DESCRIPTION	PAGE
Q-FIT I			
PLATFORMS			
ATT - 01 - 007	REP 2 - 4,5	Extendable rotating platform	pag. 9
ATT - 01 - 009	REP 2 - 5.5	Extendable rotating platform	pag. 10
ATT - 01 - 011	REP 2 - 6.5	Extendable rotating platform	pag. 10
ATT - 01 - 016	REP 10.2 - 4,7	Extendable rotating platform	pag. 14
ATT - 01 - 026	REP 5.2 - 4,5 W0,6	Extendable rotating platform + winch 600 kg	pag. 14
ATT - 01 - 018	RPRAB 10 - 3,5	Extendable rotating platform asbestos 1000kg + frontal opening	pag. 15
ATT - 01 - 020	RRP 10.2,5 - 3,5	Extendable rotating platform for roofs	pag. 15
ATT - 01 - 001	P1,4	Platform	pag. 8
ATT - 01 - 003	RP1,4	Rotating platform	pag. 8
ATT - 01 - 005	RP2,2	Rotating platform	pag. 9
ATT - 01 - 013	CRP 5	Rotating platform for tunnels	pag. 11
ATT - 01 - 022	TP 2.10	Fixed telescopic platform	pag. 16
ATT - 01 - 024	TP O-U	Telescopic Platform that can work either positive or negative TP O/U	pag. 16
WINCHES			
ATT - 02 - 001	W2,7	Winch 2,700 kg	pag. 20
ATT - 02 - 002	W3,5	Winch 3,500 kg	pag. 20
ATT - 02 - 009	W3,5 - 1,75	Winch 3,500 kg / 1,750 kg	pag. 22
ATT - 02 - 010	W3 - 6	Winch 3,000 kg / 6,000 kg	pag. 23
ATT - 02 - 004	W6	Winch 6.000 kg	pag. 21
ATT - 02 - 006	W8	Winch 8.000 kg	pag. 21
ATT - 02 - 018	W13	Winch 13,000 kg	pag. 23
ATT - 02 - 008	W16	Winch 16,000 kg	pag. 22
ATT - 02 - 012	WB6	Winch fitted at the base of the boom 6 t	pag. 24
ATT - 02 - 013	WB6	Winch fitted at the base of the boom 6 t	pag. 24
ATT - 02 - 016	WB6	Winch fitted at the base of the boom 6 t	pag. 25
ATT - 02 - 014	AWB6	Winch fitted at the base of the boom 6 t articulated for road circulation	pag. 25

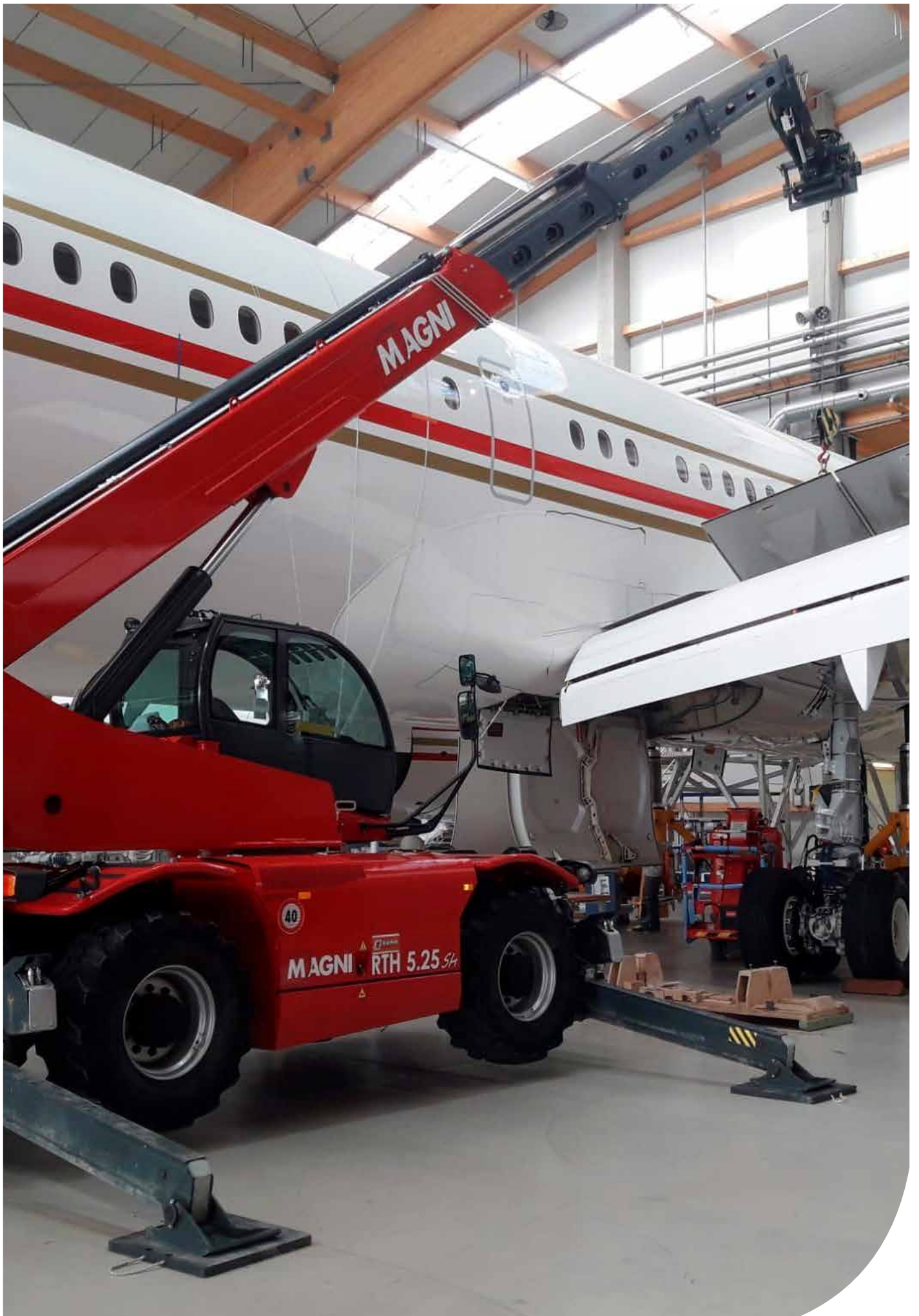

ALPHABET INDEX

CODE	PRODUCT	DESCRIPTION	PAGE
Q-FIT I			
FORK CARRIAGES			
ATT - 03 - 032	FCEP30T 2,4 R	Extendable 30 t fork carriage with positioner	pag. 45
ATT - 03 - 003	FCF5T 1,3	FEM fork carriage 5 t	pag. 30
ATT - 03 - 010	FCF6T 1,3	FEM fork carriage 6 t	pag. 33
ATT - 03 - 018	F10T	Fork carriage 10 t	pag. 36
ATT - 03 - 036	FCPT10T 1,5	Fork carriage 10 t (with fork positioner and sideshift)	pag. 37
ATT - 03 - 019	FCP10T	Fork carriage 10 t (with fork positioner)	pag. 36
ATT - 03 - 020	FC10T 2,5 C	Fork carriage 10 t (with fork positioner)	pag. 37
ATT - 03 - 021	FCP13T	Fork carriage 13 t (with fork positioner)	pag. 40
ATT - 03 - 022	F16T	Fork carriage 16 t	pag. 40
ATT - 03 - 024	FCPT16 2,4	Fork carriage 16 t (with fork positioner and sideshift)	pag. 41
ATT - 03 - 023	FCP16T	Fork carriage 16 t (with fork positioner)	pag. 41
ATT - 03 - 025	FCP16T C	Fork carriage 16 t (with fork positioner)	pag. 42
ATT - 03 - 026	FCP20T	Fork carriage 20 t (with fork positioner)	pag. 42
ATT - 03 - 027	FCP24T	Fork carriage 24 t (with fork positioner)	pag. 43
ATT - 03 - 028	FCP24T 2,4	Fork carriage 24 t (with fork positioner)	pag. 43
ATT - 03 - 029	FCP27T	Fork carriage 27 t (with fork positioner)	pag. 44
ATT - 03 - 031	FCPT30T 2,4 R	Fork carriage 30 t (with fork positioner and sideshift)	pag. 45
ATT - 03 - 030	FCP30T	Fork carriage 30 t (with fork positioner)	pag. 44
ATT - 03 - 033	FCP35T	Fork carriage 35 t (with fork positioner)	pag. 46
ATT - 03 - 037	FCP50T	Fork carriage 50 t (with fork positioner)	pag. 46
ATT - 03 - 009	FC6T 6x5 FT	Fork carriage 6 t	pag. 33
ATT - 03 - 005	PCF	Grid for load protection for FEM fork carriage	pag. 31
ATT - 03 - 038	PC	Grid for load protection for standard fork carriage	pag. 31
ATT - 03 - 034	RFC 2,5	Rotating 2,5T fork carriage	pag. 47
ATT - 03 - 001	FC5T	Standard fork carriage 5 t	pag. 30
ATT - 03 - 006	FC6T	Standard fork carriage 6 t	pag. 32
ATT - 03 - 008	FC6T	Standard fork carriage 6 t	pag. 32
ATT - 03 - 012	FC6T FIX	Standard fork carriage 6 t	pag. 34
ATT - 03 - 015	FC8T	Standard fork carriage 8 t	pag. 35
ATT - 03 - 014	FC6T 72x72 FIX	Wide fork carriage 6 t	pag. 34
ATT - 03 - 017	FC8T 72x72	Wide fork carriage 8 t	pag. 35



ALPHABET INDEX

CODE	PRODUCT	DESCRIPTION	PAGE
Q-FIT I			
JIB WITH WINCH			
ATT - 04 - 023	JCC3000	3,000kg "swan neck" jib	pag. 57
ATT - 04 - 021	JT2500	BTelescopic jib 2,500/1,500 kg	pag. 56
ATT - 04 - 009	JW1200/3000	Jib 1,200/3,000 kg with winch	pag. 52
ATT - 04 - 011	JW 1500	Jib 1,500 kg with winch	pag. 52
ATT - 04 - 017	JW2700	Jib 2,700 kg with winch	pag. 55
ATT - 04 - 013	J2000	Jib 2.000 kg	pag. 54
ATT - 04 - 015	JW 2000	Jib 2.000 kg with winch	pag. 54
ATT - 04 - 019	JW 3000	Jib 3,000 kg with winch	pag. 56
ATT - 04 - 001	J600	Jib 600 kg	pag. 50
ATT - 04 - 003	JV 800	Jib 800 kg for winch at the base of the boom	pag. 50
ATT - 04 - 005	JW800	Jib 800 kg with winch	pag. 51
ATT - 04 - 007	JW800/1500	Jib 800/1,500 kg with winch	pag. 51
HOOKS			
ATT - 05 - 001	H6	Hook 6 t	pag. 62
ATT - 05 - 003	H8	Hook 8 t	pag. 62
ATT - 05 - 005	H10	Hook 10 t	pag. 63
ATT - 05 - 013	H13	Hook 13 t	pag. 63
ATT - 05 - 007	H16S	Hook 16 t	pag. 64
ATT - 05 - 008	H20S	Hook 20 t	pag. 64
ATT - 05 - 009	H30S	Hook 30 t	pag. 65
ATT - 05 - 010	H40	Hook 40 t	pag. 65
ATT - 05 - 012	H50	Hook 50 t	pag. 66
ATT - 05 - 011	H40S	Short hook 40 t	pag. 66

CODE	PRODUCT	DESCRIPTION	PAGE
Q-FIT I			
CLAMPS			
ATT - 06 - 010	CC	Cylinder handler 11 t	pag. 75
ATT - 06 - 011	CC4,5	Cylinder handler 4.5 t	pag. 75
ATT - 06 - 008	PD CR5	Demolition grab	pag. 74
ATT - 06 - 009	PC 1000	Pipes handler 1,000 kg	pag. 74
ATT - 06 - 001	RC 4T	Rib Handler 4 t	pag. 70
ATT - 06 - 007	TC16.63 CP	Tyre handler 16 t	pag. 73
ATT - 06 - 003	TC2,5.25	Tyre handler 2.5 t	pag. 70
ATT - 06 - 004	TC3,5	Tyre handler 3.5 t	pag. 72
ATT - 06 - 005	TC3,8.49	Tyre handler 3.8 t	pag. 72
ATT - 06 - 006	TC08.63	Tyre handler 8 t	pag. 73
BUCKETS			
ATT - 07 - 006	4X1 5900	Bucket 4X1 5,900 l	pag. 82
ATT - 07 - 009	4X1 850L	Bucket 4X1 850 l	pag. 82
ATT - 07 - 001	CB 1000	Bucket 1,000 l	pag. 80
ATT - 07 - 003	CB 2000	Bucket 2,000 l	pag. 80
ATT - 07 - 004	CB 3000	Bucket 3,000 l	pag. 81
ATT - 07 - 007	BIM 2000	Waste bucket 2,000 l	pag. 81

ALPHABET INDEX

CODE	PRODUCT	DESCRIPTION	PAGE
Q-FIT I			
SPECIALI			
ATT - 08 - 016	RRP 10.25-3,5	Aircraft Maintenance platform (with proximity sensors)	pag. 96
ATT - 08 - 017	REP 5.2-6.5 W0,6	Aircraft Maintenance platform (with proximity sensors)with winch 600kg	pag. 97
ATT - 08 - 015	TFEH 4,6 T	Aircraft Turbine Engine Handler	pag. 95
ATT - 08 - 013	CH22T	Coils handler 22T (grab)	pag. 95
ATT - 08 - 012	SCT30T	Coils handler 30T (spur)	pag. 94
ATT - 08 - 010	BB600	Concrete bucket 600 l	pag. 91
ATT - 08 - 019	BB800	Concrete bucket 800 l	pag. 92
ATT - 08 - 020	BB1000	Concrete bucket 1000 l	pag. 92
ATT - 08 - 014	MB 700 SL	Concrete mixer700 l	pag. 93
ATT - 08 - 011	BM 120	Handling and demolition grapple	pag. 94
ATT - 08 - 004	MTM	Multitool - handler for multiple attachments	pag. 88
ATT - 08 - 018	RECYCLING PAPER CLAMP	Recycling paper clamp	pag. 90
ATT - 08 - 009	SNOW BLADE	Snow blade	pag. 91
ATT - 08 - 002	SCT	Suspension cylinders tool	pag. 86
ATT - 08 - 008	CBR	Tool for conveyor belt maintenance up to 25T	pag. 90
ATT - 08 - 007	VACUUM MASTER	Vacuum master	pag. 89
ATT - 08 - 006	VACUUM MULTILIFTER 500	Vacuum multilifter 500	pag. 89
ATT - 08 - 003	RWHT	Wheel hub tool	pag. 88
ATT - 08 - 001	TREE CUTTER	Tree cutter	pag. 86



#LIFT
DIFFE
RENT



MAGNI
TELESCOPIC HANDLERS

LEGENDA



CONSTRUCTION & BUILDING

Magni telescopic handlers, designed for the construction sector, allow you to position and maneuver any type of load in height or with reach with maximum safety. The intuitive controls of the touch screen display and the ergonomic and panoramic cabin with all the comforts for prolonged use by the operator, guarantee immediate operation.

- FRAMING
- DEMOLITION
- COVERING
- RESTORATION & RENOVATION



HEAVY INDUSTRIAL

Magni handling solutions are known for their reliability and performance. Even in a demanding sector such as the heavy industry, they live up to expectations for the duration of the projects: construction of sites and conduits for the passage of gas, support for activities and maintenance of machinery on site.

- OIL&GAS
- HARBOURS
- DEFENSE
- AIRPORT
- AGROINDUSTRIAL
- TUNNELS
- RAILWAYS



MINING

The HTH Magni range consisting of seven models is the perfect solution for working with exceptional performance in open-pit or underground mines. From 10 to 45 tons they are the most reliable and safest partners for working in the most demanding and extreme situations. Versatile and off-road, the machines of the HTH series save time and work in complete safety for better productivity.

- MAINTENANCE OF CYLINDERS AND JACKS
- CHANGE DUMPER TRUCK TYRES
- CONVEYOR BELTS HANDLER
- HEAVY LOGISTICS



FORESTRY

The special tree cutting attachment is the best solution for handling, moving and cutting wooden trunk, so you can handle rough logs, boards or poles in complete safety and with great precision, on stable or rough terrain.



TUNNELS

Accessori dedicati alla manutenzione e costruzione di gallerie.



BRIDGE INSPECTION

Accessories dedicated to the ordinary inspection and maintenance of bridges and viaducts.



RECYCLING

Accessory dedicated to the recycling industry.



FEATURED PROJECTS

Special applications.

